



**RUBI**

**CATALOGUE 2025**

**THE PROFESSIONAL'S  
CHOICE SINCE 1951**



## **00. About RUBI Group**

**04** Introduction

## **01. Manual tile cutting**

**32** Manual Tile Cutters

**68** Scoring wheels and accessories for manual cutters

## **02. Slab System**

**78** Cutting large tile

**88** Handling large tile

**100** Installing large tile

## **03. Electric tile cutting**

**110** Electric cutters

**140** Circular Saw, Bevelling and Vacuum Cleaner

## **04. Diamond blades**

**156** Dry cutting diamond blades

**163** Wet cutting diamond blades

## **05. Drilling**

**172** Tools for drilling ceramic tile, stoneware, marble, granite and other materials

## **06. Grinding & polishing**

**186** Grinding wheels and blades

**192** Blades and Polishing pads

<b>07.</b>	<b>Mixing</b>
<b>196</b>	Electric Mixers
<b>206</b>	Mixing Paddles

<b>08.</b>	<b>Tools for fixing tiles and finishings</b>
<b>216</b>	Trowels, Notched trowels, Floats, Rubber trowels and Spatulas
<b>231</b>	Markers, Chisels, Templates and Auxiliary tools for tiling
<b>243</b>	Mallets, Nippers and Grout Mortar Applicators

<b>09.</b>	<b>Accessories for tile fixing and finishing</b>
<b>250</b>	Measurement and guides
<b>252</b>	Tile Spacers
<b>258</b>	Levelling Systems

<b>10.</b>	<b>Rubble chutes, buckets &amp; tubs</b>
<b>264</b>	Rubble Chutes
<b>266</b>	Plastic Products for Construction

<b>11.</b>	<b>Safety equipment</b>
<b>272</b>	Safety equipment for building professionals

<b>12.</b>	<b>Accessories for cleaning and finishing</b>
<b>278</b>	Products and Accessories for cleaning and finishing of tiles

<b>13.</b>	<b>Pal box and displays</b>
<b>286</b>	Palbox and displays
<b>299</b>	Index by References





# DISCOVER THE NEW RUBI PRODUCTS **2025**

## **NEW** TK TILE CUTTER

—  
Visionaries see further



Pag. 36

## **NEW** DC-250 SMART ADVANCE

—  
True Intelligent Cutting



Pag. 118



**NEW**  
**DT-250 MAX**

Fast cutting for outdoors

Pag. 134



**NEW**  
**DL-125 · 1200**

The new light and versatile table saw

Pag. 126



# THE BEST OPTION FOR EACH JOB SINCE 1951

At RUBI Group, we are experts in the design, manufacture and distribution of revolutionary machinery and tools for cutting, laying and maintaining tiles. Our relentless dedication to excellence has positioned us as the undisputed leaders in the industry. Every product we create is the result of our passion for innovation and our unwavering commitment to quality.

cutter in history, invented and patented by the Boada brothers in 1951, RUBI has always worked with a clear mission: to provide differentiated solutions to construction professionals by providing maximum efficiency, profitability and safety for the optimal installation of ceramic tiles.

In this way, by placing the installer at the centre of our strategy, we ensure that **innovation, the high quality of our products and excellence are fundamental principles throughout our product range**. The RUBI brand is currently recognised by the most demanding construction and design professionals in more than 120 countries, thanks to our robust international network of subsidiaries and branches.

## WE PROVIDE QUALITY AND INNOVATION TO THE WORLD



# RUBI IS RUBI ALL OVER THE WORLD

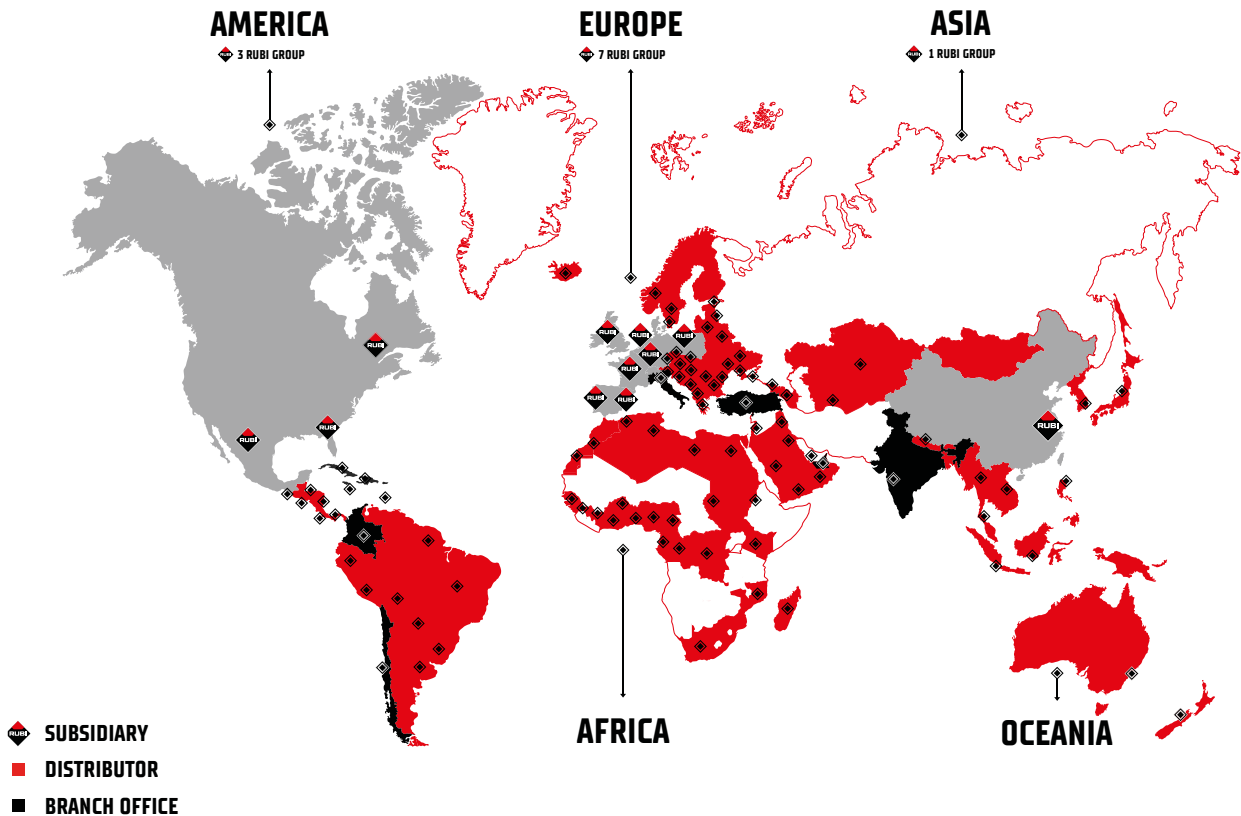

**+600** People in the RUBI Team

**120** Countries with RUBI brand distribution

**2** Production and logistics centres

**+100** Official Distributors

**11** International subsidiaries

At RUBI Group, our multidisciplinary team is highly qualified and undergoes continual training. We are firmly committed to excellence, respect and passion, core values that guide our actions every day.

Our team is made up of more than 600 professionals in 11 subsidiaries and 9 branches around the world. Our experience and knowhow support us in providing quality solutions at an international level.



# BETTER PROFESSIONALS. BETTER PLACES.

## THE RUBI 'BETTER PROFESSIONALS, BETTER PLACES' COMMITMENT.

At RUBI Group we are guided by our corporate purpose "Better Professionals. Better Places" that reflects our focus on two fundamental aspects, improving the quality and performance of our industry through the professionals whose talent is recognised by all, as well as the places they transform with their creativity.

We strive to change the future by being leaders in training exceptional professionals and contributing to building exceptional places, for the benefit of a better world.

## SDG FOR A SUSTAINABLE AND EQUITABLE FUTURE

Our commitment focuses on sustainable development as part of our Corporate Social Responsibility strategy, which encompasses the three key areas of sustainability: social, environmental and economic.

In doing so, we draw on 8 of the 17 Sustainable Development Goals (SDGs) set by the United Nations for the period 2015–2030, which guide us on our path towards a future with a focus on sustainability.

We firmly believe that environmental policies and social and economic sustainability are the responsibility of the



Training for construction students at the BTP CFA apprenticeship centre in Antibes, France.



Collaboration with the Vicente Ferrer Foundation in the construction of housing for vulnerable people in Anantapur, India.





entire RUBI team. Only in a fairer, more equal and more sustainable world can we continue growing and working together with society and our environment.

# TOGETHER WE ARE BUILDING A SUSTAINABLE AND EQUITABLE FUTURE FOR ALL.



Beach clean-up in Florida by RUBI Tools USA team.



At Rubi we are a multidisciplinary team with great expertise and ongoing training.

The RUBI Team, made up of more than 600 professionals, works in the numerous subsidiaries and branches that the RUBI Group has at international level.

## **OUR DAY-TO-DAY WORK IS ALWAYS CARRIED OUT ACCORDING TO THE 3 RUBI VALUES**



## EXCELLENCE

Excellence defines us in all we do, thanks to our experience, flexibility and innovation. We strive each day to offer the best in our innovative products and our relationships with partners in the sector.

## RESPECT

Respect is in our DNA, our relationships within the RUBI Team as well as with customers, suppliers and other stakeholders enable us to create a close-knit and dynamic environment.

## PASSION

Passion is what moves us, our attitude to work through our commitment, optimism and determination. Our long history demonstrates our sustained enthusiasm over time – we love to inspire others.



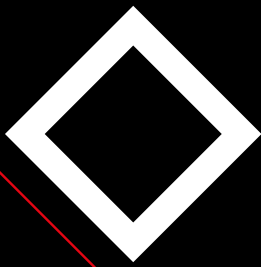

# RUBI ACADEMY

## LET'S BUILD BETTER PLACES TOGETHER!

The RUBI Academy is a pioneering project designed to professionalise and promote the tiler's trade, aimed at present and future ceramics professionals.

With more than 70 years' experience in training and supporting ceramic tile installers, we bring together all our training activities in an inclusive and accessible space: the RUBI Academy.

The RUBI Academy promotes learning opportunities through a wide range of international training events, webinars, downloadable tutorials and audio-visual content available on our website.

In addition to these training actions, the RUBI Academy supports initiatives such as the "RUBI Scholarship", which promotes specialisation in tile installation among young students and collaborates in training events aimed at women in the construction industry or unemployed people who are continuing their training.

The main base of the RUBI Academy is located in our facilities in Santa Oliva, where it has a physical space dedicated to training. It has a classroom for theory classes and another space with more than 580 square metres for practical training.

In this way, the RUBI Academy is consolidated as an accessible and quality training space, which also serves as an in-person and virtual meeting point for professionals in the sector. We value and raise the profile of the tiler's trade, bringing it closer to people and acknowledging the important role of ceramic tile installers in the construction industry.



**FOLLOW US ON  
OUR YOUTUBE  
CHANNEL  
TO SEE ALL  
THE TRAINING  
VIDEOS**







# PRODUCTION FACILITIES

RUBI Group has 2 production centres in Santa Oliva (Tarragona, Spain) and Suzhou (China), which translates into more than 120,000 m<sup>2</sup> of facilities worldwide.

Our main production and logistics centre in Santa Oliva (Tarragona, Spain) covers a surface area of 27,000 m<sup>2</sup> and is equipped with the most advanced technology for logistics management. Moreover, thanks to the innovative SRT centre (Suzhou, China) we guarantee the stock availability of our products throughout the different geographical areas in which RUBI operates, meeting demanding service level ratios. Both production centres are also equipped with the latest production and logistics technology to ensure that we obtain high-quality products and a shipping service that minimises delivery times.



## SHOWROOMS IN SUBSIDIARIES

RUBI's 11 subsidiaries cover global demand and the training and after-sales service, together with our trusted distributors, so we are always close to the user and can offer them solutions adapted to the characteristics of each market. In addition, in several of them, including our headquarters, we have modern showrooms displaying our latest market launches. We offer, in this way, an updated and innovative experience to our customers and users, showing how RUBI products meet the needs of the tiler in line with the new trends in the ceramic industry.



Showroom at RUBI Portugal's premises

## CORPORATE MUSEUM

Since 1951, the RUBI team has been passionately devoted to professionalising the construction trades. As a reflection of our commitment, in 2003 we opened "The Tools of Construction" Corporate Museum at our main facilities in Santa Oliva, Tarragona. The museum is open to customers, professionals and students, providing them with a unique educational experience. They will be able to explore our historical collection of RUBI construction tools and test their skills in cutting and laying tiles.

HISTORY AND  
INNOVATION COME  
TOGETHER TO DRIVE  
GROWTH AND  
EXCELLENCE IN THE  
SECTOR.



## AFTER-SALES SERVICE

RUBI's after-sales team, together with our extensive network of official technical services, work daily to deal as efficiently as possible with incidents and any questions and needs our customers and professionals may have regarding the cutting and laying of ceramic tiles.

At RUBI Group, we lead the market with high and fast response rates, thus achieving exceptional customer satisfaction worldwide. We guarantee superior performance in our tools, providing a long-lasting and satisfying purchasing experience with impeccable customer service.

There are a number of ways for you to contact us:



[rubi.com](http://rubi.com)



[aftersales@rubi.com](mailto:aftersales@rubi.com)



+34 936 80 65 00







# RUBI CLUB

**RUBI CLUB** members are always one step ahead of other tile laying professionals, thus gaining greater profitability and prestige for their business.

At RUBI, all products give you points that can be conveniently changed for money or gifts, and you get great discounts just for registering your purchases. You can also extend the useful life of your tools, with the free warranty extension of up to 5 years, and get the most out of your investments. Thanks to our new products and exclusive promotions for **RUBI CLUB** members, you can work with the best tools under the best conditions.

Currently, more than 70,000 experts in the art of tile laying around the world already trust **CLUB RUBI** to make them better professionals and deliver their projects in the most efficient way.

**Join the top community of tile laying experts worldwide and benefit from all its advantages!**



**GET MONEY BACK ON YOUR PURCHASES**



**EXTEND THE WARRANTY FREE OF CHARGE**



**ACCESS EXCLUSIVE PROMOTIONS**



**RECEIVE INVITATIONS FOR EVENTS**



**ENJOY UNIQUE CONTENT**



**PARTICIPATE IN COMPETITIONS AND DRAWS**





# RUBI CLUB

## ★★★★★ THE APP THAT REWARDS YOUR TRUST IN US

Get money back on all your purchases

DOWNLOAD THE APP AND START ENJOYING ALL THE BENEFITS



DOWNLOAD IT AND START ACCUMULATING POINTS

Scan the QR code or find it in app stores



At RUBI, innovation and quality are fundamental pillars in everything we do: from the conception of the design, through the production phase, and finally reflected in our products. We are proud to offer solutions that enable the tiling professional to carry out their work with creativity and good attention to detail, obtaining optimum results of the highest quality.

## TECHNOLOGICAL LEADERSHIP

**119** Patented products

**119** Protected products with industrial design



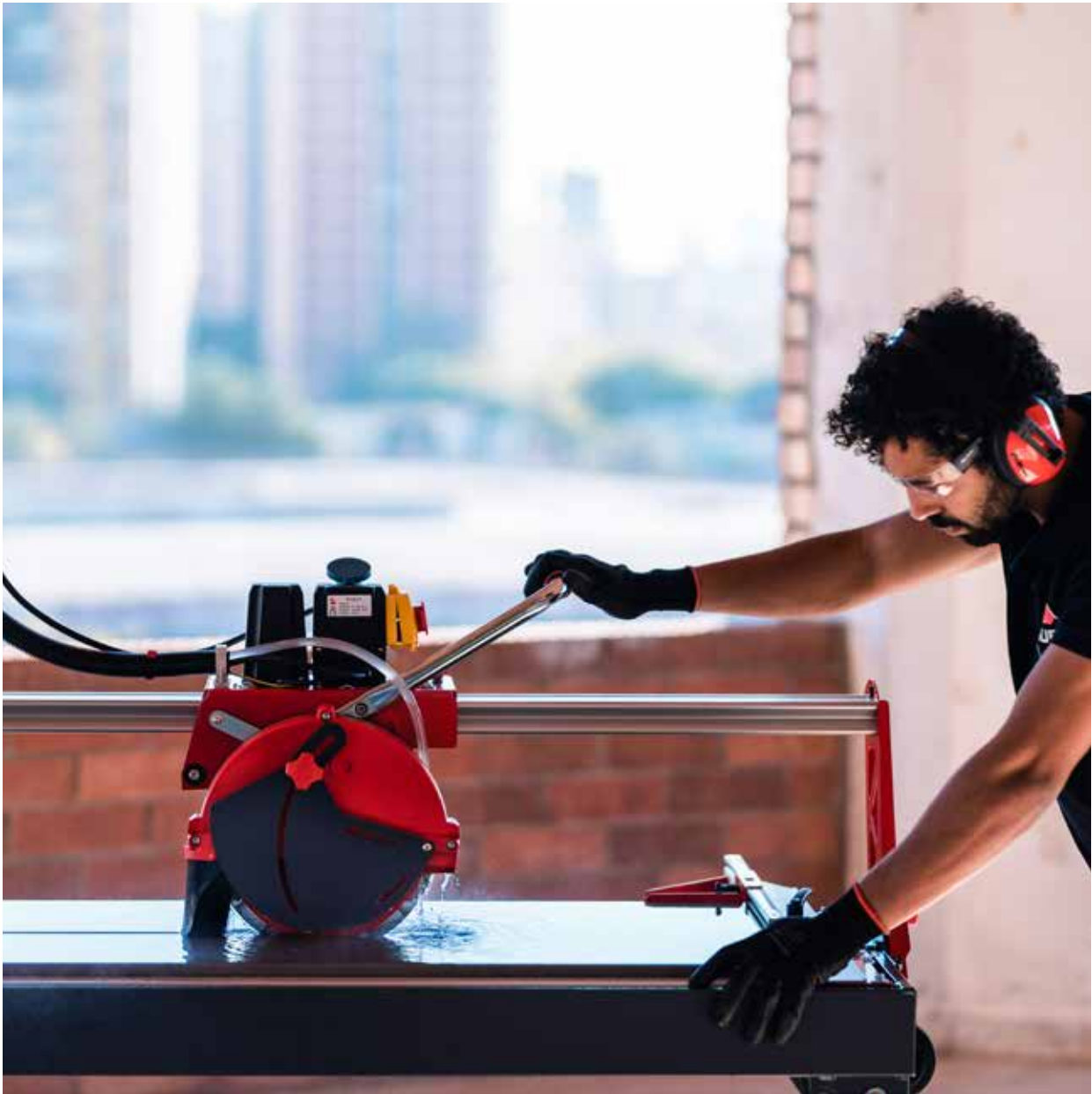

## INNOVATION

We are constantly researching and developing new solutions based on the evolution of market and technology trends, our own experience and ongoing conversations with end users, our partners and other professionals.

## QUALITY

We only use materials of the highest quality and we work in compliance with strict design and manufacturing standards in order to offer tools with the performance levels that our customers expect.

## GUARANTEE

We strive to offer greater durability in our products and a peace of mind that comes from our long track record, also backed up by a customer support service and constant communication with the same global nature.

## SOLUTIONS

Understanding and helping to shape our industry for generations has allowed us to create a wide range of tools that provide excellence and efficiency in the cutting and laying of tiles.



# SECURE LOCK SYSTEM

## QUICK HEIGHT ADJUSTMENT

Mounting in pre-set positions is done quickly and easily, providing maneuverability and versatility in the daily use of the scoring wheel.

## SAFE AND PRECISE INSTALLATION

While turning the handle to secure the wheel definitively once positioned, the wheel remains stable and attached to the mechanism.

## EFFICIENCY AND COMFORT

The handle design allows for easy insertion into the tool holder, improving efficiency and comfort during use.

## VERTICAL SLOTS FOR CENTERING AND ALIGNMENT

The vertical slot design is intended to enhance centering and alignment of the assembly during maneuvers. Patented design.

## BRAND PROTECTION SYSTEM

The system prevents the use of unauthorized wheel handles, protecting our brand and ensuring exclusive use of our cutting wheels.

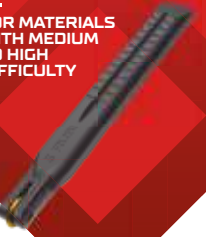
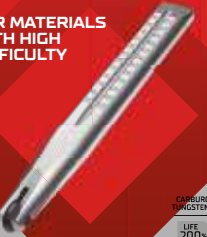
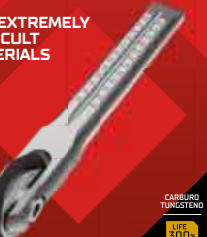

# "SLS" 4TH GENERATION SCORING WHEELS

<p><b>NEW PATENT</b> ★★★★★ <b>SILVER</b> FOR MATERIALS WITH LOW TO MEDIUM DIFFICULTY</p>  <p>CARBURD TUNGSTENO LIFE 100%</p> <p>For cuts with low to medium difficulty in ceramic and porcelain.</p>	<p><b>NEW PATENT</b> ★★★★★ <b>GOLD</b> FOR MATERIALS WITH MEDIUM TO HIGH DIFFICULTY</p>  <p>CARBURD TUNGSTENO LIFE 150%</p> <p>For cuts with medium to high difficulty in ceramic and porcelain.</p>	<p><b>NEW PATENT</b> ★★★★★ <b>ENDURE</b> FOR MATERIALS WITH HIGH DIFFICULTY</p>  <p>CARBURD TUNGSTENO LIFE 200% LONG LIFE Hard materials</p> <p>For cuts of high difficulty in ceramic and porcelain.</p>	<p><b>NEW PATENT</b> ★★★★★ <b>EXTREME</b> FOR EXTREMELY DIFFICULT MATERIALS</p>  <p>CARBURD TUNGSTENO LIFE 300% EXTREMELY LONG LIFE Hard materials</p> <p>For cuts with extreme difficulty in ceramic and porcelain.</p>
---	---	--	---

## COMPATIBILITY TABLE

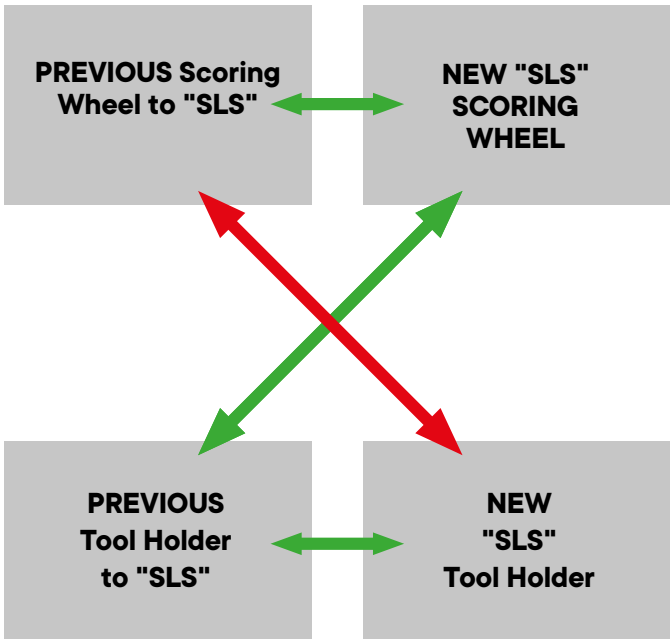

### THE NEW "SLS" SCORING WHEELS ARE COMPATIBLE WITH ALL CUTTERS

The new SLS scoring wheels are compatible with both cutters that feature the new SLS-marked tool holder and cutters with the previous tool holder.

### SCORING WHEELS PREVIOUS TO THE NEW "SLS" VERSION ARE NOT COMPATIBLE WITH CUTTERS FEATURING THE "SLS" TOOL HOLDER

Unlike the new SLS scoring wheels, previous versions lose compatibility with the new manual cutters featuring the SLS marking.



# PARTNERSHIP WITH CAS

RUBI & CAS work to offer professionals battery-powered tools for ceramic tile installation with total freedom of movement. CAS batteries are compatible with more than 35 brands and over 300 products, making it a low-cost, high-performance solution for tilers. From RUBI, we have created and launched 4 innovative and revolutionary products with this leading technology.

CAS LI-ION 18V BATTERY COMPATIBLE WITH METABO 18V CORDLESS TOOLS AND ALL OF THOSE THAT FORM PART OF THE CAS PLATFORM.

## THUMPING SYSTEM QUAKE ENERGY

18V



- Stepless speed 0-10000r/min
- Highly ergonomic
- Bimaterial handles
- Reliable suction force
- Light

## RUBIMIX E-9 ENERGY CAS

18V



## RUBI LUMEO

18V



- Waterproof high IP (IP65)
- 4000 lumen
- Dimmer in 5 steps
- Extra power bank (Backup battery)

## ANGLE GRINDER TECH

18V



- Brushless Motor High efficiency
- Soft start 10.000 RPM
- 100-125 mm 4"-5"
- Ref. 52949 - EU: 22mm - 7/8"

## MIXER RUBIMIX E-10 ENERGY

18V



- Brushless Motor High efficiency
- Light
- Ergonomic Resistance
- FAST-IN included



CAS BATTERY LI-POWER 12V COMPATIBLE WITH METABO BRAND 12V BATTERY TOOLS AND WITH ALL THOSE THAT ARE PART OF THE CAS PLATFORM.

## THUMPING SYSTEM RUBI TRILLER ENERGY

12V



- 3-100 mm 1/8"-3 15/16"
- 4,8 Kg 11 lb
- Vibration speed regulator





# CAS BATTERIES

12/18V 2.0/4.0/5.2AH



## Battery-powered tools for tile installers

**1** COMPATIBLE WITH MORE THAN 40 BRANDS AND OVER 400 PRODUCTS

**2** FREE MOVEMENT



Save time



1 battery pack for many brands



Save money



Save resources



Largest multi-manufacturer battery pack system



100% compatible

## Cas battery compatibility

18 V 5,2 Ah	✓	✓	✓	✓	✓	✗
18 V 2.0 Ah	✓	✓	✓	✓	✓	✗
12 V 2.0 Ah	✗	✗	✗	✗	✗	✓
12 V 4.0 Ah	✗	✗	✗	✗	✗	✓

The charger is compatible with all batteries.



# THE RUBI EXPERIENCE

## 5 STEPS TO EXCELLENCE

RUBI ensures quality, efficiency and creativity from start to finish at every stage of the tile installation process.

This basic signage across our entire product range helps the professional find the right tool for the task at hand, providing a clear and visual solution.

Our portfolio is now organised into these 5 categories, which have been defined taking into account our customers' testimonials about their own work processes, in the more than 120 countries where we operate.



## 1. Preparation

This phase includes all the processes prior to the installation of ceramic and porcelain tiles, starting with the preparation and making good of the substrates and the checking of levels, followed by the layout and design of the joint pattern and ending with the preparation and application of the tile adhesive.



## 2. Cutting and Drilling

Although after the preparation of the adhesive, this logically takes us to the installation stage, RUBI has included the cutting and drilling phase in second place. The reason is very simple, if we take into account that the tile needs to be cut (or drilled), it cannot be installed until this step has been carried out. All installations require tiles to be adapted and resized to the installation space and, whether it is to a greater or lesser extent, a ceramic tile will always have to be cut (or drilled).



## 3. Installation

In this stage, we mainly focus on bringing together all the necessary tools to ensure proper handling and installation of the tile, obtaining the best results both in flatness and alignment in order to make the setting-out design a reality with maximum precision.



## 4. Grouting

As its name indicates, this stage includes all the tools necessary for the filling and definition of the tile joint, as well as the removal of excess material and a first cleaning stage.



## 5. Cleaning

As it must do, the last stage brings together everything that is necessary to deliver the perfect job. The final cleaning of any ceramic tile installation process will always make the first impression on any user. For this reason, it is as important as any of the previous stages.





# MANUAL TILE CUTTING



Manual Tile Cutters  
Scoring wheels and accessories for manual cutters



# SELECTION TABLE

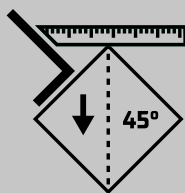
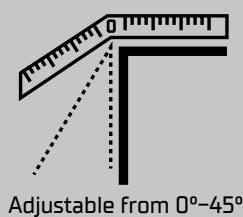

			MAX	
			cm	inch
<b>PREMIUM</b>	••• Intensive	TZ	85, 102, 130, 155, 180	33 3/8, 40 3/8, 51 3/8, 61 3/8, 70 3/8
		TK	85, 102, 130, 160	33 3/8, 40 3/8, 51 3/8, 63
		TX-MAX	71, 102, 125	27 13/16, 40 3/8, 49 3/8
<b>SUPERPRO</b>	••• Intensive	TP-S / TP-T	66, 75, 93, 125	26, 29 1/2, 36 3/8, 49 3/8
		TR-MAGNET	60, 71	23 3/8, 27 13/16
<b>PRO</b>	••• Professional	RCH RS	85, 120, 160	33 3/8, 47 1/4, 63
		RCH		
		HIT PLUS RS	160	63
		HIT PLUS	120, 160, 180	47 1/4, 63, 70 3/8
		HIT N	85, 100, 120	33 3/8, 39 3/8, 47 1/4
		TS MAX	43, 57, 66, 75	16 13/16, 22 7/16, 26, 29 1/2
		SPEED MAGNET	62, 72, 92	24 3/8, 28 3/8, 36 1/4
	••• Professional	SPEED N	62, 72, 92	24 3/8, 28 3/8, 36 1/4
	••• Professional	FAST	65, 85	25 3/8, 33 3/8
	••• Professional	STAR PLATINUM	51, 63	20 3/8, 24 13/16
	••• Professional	STAR	42, 51, 63	16 3/8, 20 3/8, 24 13/16
	••• Professional	PRACTIC	51, 61	20 3/8, 24 3/8
	••• Professional	BASIC	60	24



kg	lb		mm	inch	TILE	STONEWARE	PORCELAIN
1500	3306.93	Adjustable	21*	1 <sup>3</sup> / <sub>16</sub>	<input checked="" type="checkbox"/>	<input checked="" type="checkbox"/>	<input checked="" type="checkbox"/>
1200	2645.54				<input checked="" type="checkbox"/>	<input checked="" type="checkbox"/>	<input checked="" type="checkbox"/>
1000	2204.62		20*	1 <sup>3</sup> / <sub>16</sub>	<input checked="" type="checkbox"/>	<input checked="" type="checkbox"/>	<input checked="" type="checkbox"/>
800	1763.7		15	5/ <sub>16</sub>			
950	2094.39	Fixed	18	1 <sup>1</sup> / <sub>16</sub>	<input checked="" type="checkbox"/>	<input checked="" type="checkbox"/>	<input checked="" type="checkbox"/>
900	1984.16		18	1 <sup>1</sup> / <sub>16</sub>	<input checked="" type="checkbox"/>	<input checked="" type="checkbox"/>	<input checked="" type="checkbox"/>
					<input checked="" type="checkbox"/>	<input checked="" type="checkbox"/>	<input checked="" type="checkbox"/>
800	1763.7		15	5/ <sub>16</sub>	<input checked="" type="checkbox"/>	<input checked="" type="checkbox"/>	<input checked="" type="checkbox"/>
					<input checked="" type="checkbox"/>	<input checked="" type="checkbox"/>	<input checked="" type="checkbox"/>
					<input checked="" type="checkbox"/>	<input checked="" type="checkbox"/>	<input checked="" type="checkbox"/>
			15	5/ <sub>16</sub>	<input checked="" type="checkbox"/>	<input checked="" type="checkbox"/>	
			12	3/ <sub>8</sub>	<input checked="" type="checkbox"/>	<input checked="" type="checkbox"/>	
					<input checked="" type="checkbox"/>	<input checked="" type="checkbox"/>	
					<input checked="" type="checkbox"/>	<input checked="" type="checkbox"/>	
		10	3/ <sub>8</sub>	<input checked="" type="checkbox"/>	<input checked="" type="checkbox"/>		
				<input checked="" type="checkbox"/>			

TZ

**MAXIMUM POWER, THE MOST ADVANCED MANUAL CUTTER ON THE MARKET.**

For intensive cutting of all types of ceramic tile, ideal for porcelain stoneware and extruded stoneware.



CATEGORY: PREMIUM



USE: INTENSIVE



MATERIAL: PORCELAIN TILE

POWER  
1500 kg

- **Powerful breaking system (up to 1.500 kg), operable with just one hand.**
- **Accurate with soft slider movements.**
- **Large cutting capacity, up to 21mm thickness. Ideal for large format tiles\*.**
- **Robust with a foldable structure for high strength and easy transportation.**
- Excellent performance breaking system: Clean cuts with soft motion.
- Robust chassis, guides and breaking system.
- Swivel square with central pivot for fast and accurate measurements in angle cutting.
- Adjustable lateral stop for repetitive cuts.
- Support base for excellent tile placement.
- Easy to transport: rubber wheels with bearings and handle.
- Interchangeable scoring wheels ranging from Ø 8mm -22mm.
- Includes Ø 8 mm SILVER and Ø 22 mm EXTREME scoring wheels. Reinforced textile bag for transport and protection.
- On models 1300/1550/1800: The reinforced textile bag of these models includes 2 built-in wheels.





**SECURE LOCK SYSTEM**

Only compatible with LOCK SYSTEM SCORING WHEELS



REF.								
<b>TZ-850</b>	17952	√	33 1/2" 85 cm	23 5/8x23 5/8" 60x60 cm	1/8-7/8" 3-21 mm	3306.9 lb 1500 kg	49.38304 lb 22.4 kg	9
<b>TZ-1020</b>	17951		40 1/8" 102 cm	27 1/2x27 1/2" 70x70 cm			54.23316 lb 24.6 kg	
<b>TZ-1300</b>	17953		51 1/8" 130 cm	35 3/8x35 3/8" 90x90 cm			66.138 lb 30 kg	
<b>TZ-1550</b>	17954		61 1/8" 155 cm	43 1/4x43 1/4" 110x110 cm			72.7518 lb 33 kg	
<b>TZ-1800</b>	17924		70 7/8" 180 cm	47 1/4x47 1/4" 120x120 cm			79.938796 lb 36.26 kg	

\*Some materials with a thickness greater than 9/16" [15 mm] may be difficult to cut manually due to physical characteristics, internal tensions and/or finish. We recommend making sample cuts to determine product compatibility and alternatively suggest cutting these types of material using an electric tile cutter.

**ACCESSORIES**



**REF. 18980**  
Maintenance Kit





CRAFTING  
NEEDS  
HARD WORK  
INNOVATION



## NEW TK TILE CUTTER

Meet the first asymmetric monoguide tile cutter worldwide

We know you work hard and you probably workout. But you don't need two strong arms when you have:

- Perfect visibility
- 1500kg breaking power
- Breakage control
- Cut up to 21mm
- Incredibly smooth cut
- Great stability
- Easy transport and folding

**VISIONARIES SEE FURTHER**



**THE WORLD'S FIRST  
ASYMMETRICAL MONOGUIDE  
CUTTER FOR PROFESSIONALS  
WITH ALL THE INNOVATION  
AND QUALITY OF RUBI.**



Working smart is about optimising processes, simplifying them and looking for new ways to improve results. It often means breaking with the status quo and looking beyond it.

**VISIONARIES SEE FURTHER**

TK

**REVOLUTIONARY CUTTER WITH FORMIDABLE BREAKING POWER AND EXCEPTIONAL VISIBILITY OF THE SCORING LINE.**

For intensive cutting of all types of ceramic tile, ideal for porcelain stoneware and extruded stoneware.



CATEGORY: PREMIUM



USE: INTENSIVE



MATERIAL: PORCELAIN TILE



MONOGUIDE



CUTTING VISIBILITY

7/8 in  
21 mm3306.9 lb  
1500 kgPURE  
POWER

PATENTED

- **Pure Power. 1500kg maximum breaking force combined with a mechanism that allows to score and break with one hand.**
- **Offset guide. Perfect visibility of the scoring wheel. Same visibility as RUBI double guide cutters.**
- **Large cutting capacity, up to 21mm thickness. Ideal for large format tiles\*.**
- **Robust and foldable. The tandem “guide-chassis” gives the TK greater robustness and always reduces flexing of the assembly. The design of the machine in the folded position makes it easy to transport, both inside and outside the bag.**
- Equipped with radial bearings for smoother and more accurate movement. Particularly suitable for heavy duty applications.
- Closed profile extruded aluminium guide with chromed steel raceway.
- Die-cast aluminium guide supports.
- Soft grip handle for improved ergonomics and comfort.
- 30 cm long side stop swivels from 45° to 90° for repeat cuts.
- Rubber wheels and handle for easy transport.
- Reinforced textile carrying case for transport, protection and durability.
- Compatible with Secure Lock System (SLS) PLUS scoring wheels.
- Supplied with Ø8 SILVER PLUS and Ø22 EXTREME PLUS scoring wheels.



**SECURE LOCK SYSTEM**

Only compatible with LOCK SYSTEM SCORING WHEELS



REF.									
<b>TK-850</b>	15956	√	33 1/2" 85 cm	23 5/8x23 5/8" 60x60 cm	1/8-7/8" 3-21 mm	3306.9 lb 1500 kg	-	-	
<b>TK-1020</b>	15957		40 1/8" 102 cm	27 1/2x27 1/2" 70x70 cm					56.2173 lb 25.5 kg
<b>TK-1300</b>	15958		51 1/8" 130 cm	35 3/8x35 3/8" 90x90 cm					57.3196 lb 26 kg
<b>TK-1600</b>	15959		62" 160 cm	43 1/4x43 1/4" 110x110 cm					71.6495 lb 32.5 kg
								74.9564 lb 34 kg	

\*Some materials with a thickness greater than 9/16" (15 mm) may be difficult to cut manually due to physical characteristics, internal tensions and/or finish. We recommend making sample cuts to determine product compatibility and alternatively suggest cutting these types of material using an electric tile cutter.

\*\*The pictures of this product might be slightly different to its final version.

**ACCESSORIES**



**REF. 18980**  
Maintenance Kit

## TX-MAX

**PROFESSIONAL MANUAL CUTTER WITH HIGH-PERFORMANCE MULTIPPOINT BREAKER.**  
For intensive cutting of all types of ceramic tile, ideal for porcelain stoneware and extruded stoneware.



CATEGORY: PREMIUM



USE: INTENSIVE



MATERIAL: PORCELAIN TILE



POWER  
1200 kg



7/8 in  
21 mm



2645.52 lb  
1200 kg



PATENTED

- **Highly precise scoring.**
- **Entire system highly efficient.**
- **Reinforced components. Heavy duty.**
- **High breaking power (2646 lb) - MASTER POWER. One-handed operation.**
- Head with extra-long aluminium sliders with "self-lubricating" friction bearings.
- Portable breaker with aluminium pressure pad, equipped with plastic protector to avoid marking delicate surfaces. Better visibility of the scoring and cutting zone.
- The pressure pad is locked by a ratchet mechanism and is unlocked by the trigger, allowing one-handed scoring and breaking for faster use. Increases performance with both thin and thick materials.
- Injected-aluminium base, reinforced with a central rib, for increased strength.
- Floating tables and supplementary arms for large-size ceramic tile, increasing cutting stability.
- Rotating square, with central pivot point and lateral end stop. Greater precision in angle cuts.
- Handle with soft grip for better ergonomics and comfort.
- Equipped with Ø5/16" (8 mm) SILVER and Ø 7/8" (22 mm) EX TREME scoring wheels. Compatible with the entire plus line of scoring wheels.
- Includes a carrying case (the 1250 model is equipped with wheels to transport the machine).



**SECURE LOCK SYSTEM**

Only compatible with LOCK SYSTEM SCORING WHEELS



	REF.								
<b>TX-710 MAX</b>	17909	√	27" 71 cm	19 5/8x19 5/8" 50x50 cm	1/8-7/8" 3-21 mm	2645.52 lb 1200 kg	29.32118 lb 13.3 kg	1	10
<b>TX-1020 MAX</b>	17915		40 1/8" 102 cm	27 1/2x27 1/2" 70x70 cm			42.76924 lb 19.4 kg		
<b>TX-1250 MAX</b>	17921		49 1/4" 125 cm	33 1/2x33 1/2" 85x85 cm			57.3196 lb 26 kg		

\* There are some materials over 9/16" [15 mm] thick which, due to their physical properties, possible inner or surface tensions, are difficult to cut manually. It is recommended to make some sample cuts to determine the compatibility of the product.

**ACCESSORIES**



**REF. 18980**  
Maintenance Kit



## TP-S

**SINGLE GUIDE WITH MULTIPOINT SEPARATOR AND ANGULAR MEASUREMENT.**

Ideal for high quality cutting of ceramic and porcelain tiles.



  
CATEGORY: SUPERPRO

  
USE: INTENSIVE

  
MATERIAL: PORCELAIN TILE

  
MONOGUIDE









PROTECTED  
DESIGN

- **Guide system highly resistant to impacts resulting in longer product life.**
- **Ergonomic handle with incorporated separator for greater speed and ease of use.**
- **Swivel bracket with central pivot for fast and accurate measurements.**
- **Long-lasting laser engraved square.**
- Reinforced pressure pad.
- 12 mm reinforced guide. Greater bending resistance and increased precision.
- Lateral end stop for making repetitive precision cuts.
- Two-layer base with shock-absorbing effect. Base extension for large sizes. Carrying handle. (TP-66-S and TP-75-S).
- Assembly designed to be used by pushing the handle.
- RUBIFLEX bi-material handle.
- Ø 22mm EXTREME scoring wheel included. (Ref. 01901).





	REF.							
<b>TP-66 S</b>	12954	25" 66 cm	18 1/8x18 1/8" 46x46 cm	1/4-3/4" 5-20 mm	2204.6 lb 1000 kg	25.3529 lb 11.5 kg	1	12
<b>TP-75 S</b>	12956	29 1/2" 75 cm	20 7/8x20 7/8" 53x53 cm			26.4552 lb 12 kg		
<b>TP-102 S</b>	11900	40 1/8" 102 cm	27 1/2x27 1/2" 70x70 cm			39.24188 lb 17.8 kg		
<b>TP-125 S</b>	11973	49 1/4" 125 cm	33 1/2x33 1/2" 85x85 cm			54.0127 lb 24.5 kg		

\*Some materials with a thickness greater than 9/16" [15 mm] may be difficult to cut manually due to physical characteristics, internal tensions and/or finish. We recommend making sample cuts to determine product compatibility and alternatively suggest cutting these types of material using an electric tile cutter.

#### ACCESSORIES



**REF. 18980**  
Maintenance Kit



## TP-T

**SINGLE GUIDE CUTTER WITH MULTIPOINT SEPARATOR AND ANGULAR MEASUREMENT.**

Ideal for high quality cutting of ceramic and porcelain tiles.



  
CATEGORY: SUPERPRO

  
USE: INTENSIVE

  
MATERIAL: PORCELAIN TILE

  
MONOGUIDE



- **Single guide system highly resistant to impacts. Longer life.**
- **Separator set with height adjustment. Optimum separation for each thickness.**
- **Swivel bracket with central pivot for fast and accurate measurement of angular cuts.**
- **Long-lasting laser engraved square.**
- Reinforced pressure pad. 12 mm reinforced guide. Greater bending resistance and increased precision. Lateral end stop for making repetitive precision cuts. Two-layer base with shockabsorbing effect. Base extension for large sizes. Carrying handle. (TP-66-T and TP-75-T).
- Assembly designed to be used by pulling the handle.
- RUBIFLEX bi-material handle. Ergonomic and heavy duty construction.
- Cut thickness adjustment system with 3 settings (6-9 mm/9-12 mm/12-20 mm)\*, fast and precise.
- Ø 22mm EXTREME scoring wheel included (Ref. 01901).



	REF.							
<b>TP-66 T</b>	12955	25" 66 cm	18 1/8x18 1/8" 46x46 cm	1/4-3/4" 5-20 mm	2204.6 lb 1000 kg	25.3529 lb 11.5 kg	1	12
<b>TP-75 T</b>	12957	29 1/2" 75 cm	20 7/8x20 7/8" 53x53 cm			26.4552 lb 12 kg		
<b>TP-102 T</b>	11901	40 1/8" 102 cm	27 1/2x27 1/2" 70x70 cm			36.15544 lb 16.4 kg		
<b>TP-125 T</b>	11974	49 1/4" 125 cm	33 1/2x33 1/2" 85x85 cm			50.7058 lb 23 kg		

\*Some materials with a thickness greater than 15 mm may be difficult to cut manually due to physical characteristics, internal tensions and/or finish. We recommend making sample cuts to determine product compatibility and alternatively suggest cutting these types of material using an electric tile cutter.

ACCESSORIES



REF. 18980  
Maintenance Kit



# TR-MAGNET

**SUITABLE FOR DIAGONAL CUTS WITH A REVOLVING SQUARE FOR HIGH ACCURACY.**  
For intensive cutting of porcelain tiles and ceramic tiles.



CATEGORY: SUPERPRO

USE: INTENSIVE

MATERIAL: PORCELAIN TILE

SWIVEL SQUARE



5/8 in  
15 mm

1763.68 lb  
800 kg

- **Fast operating system with magnet, for one handed use.**
- **Reinforced operating material. Increased breaking power.**
- **Revolving square with central pivot for fast and accurate measurements for cutting angles.**
- **Floating base with shock absorber for better tile breaking.**
- Solid steel guides, Ø 20 mm, chrome-plated and rectified, with anti-corrosion treatment for increased torsional strength.
- Multipoint breaker 800 kg of power.
- Heavy-duty metal arms.
- Handle reinforced with SOFT-GRIP.
- Lateral end stop for making repetitive cuts.
- Base extension for large sizes.
- Two-layer base with shock-absorbing effect.
- High-strength aluminium base.
- Interchangeable scoring wheels from 6 to 22 mm.
- With Ø 10mm SILVER and Ø 22mm EXTREME scoring wheels and carrying case included.



**SECURE LOCK SYSTEM**

Only compatible with LOCK SYSTEM SCORING WHEELS



	REF.								
<b>TR-600 MAGNET</b>	17905	√	23 5/8" 60 cm	16 1/2x16 1/2" 42x42 cm	1/8-5/8" 3-15 mm	1763.68 lb 800 kg	30.64394 lb 13.9 kg	2	18
<b>TR-710 MAGNET</b>	17906		27" 71 cm	19 5/8x19 5/8" 50x50 cm			34.1713 lb 15.5 kg	1	15

**ACCESSORIES**

**REF. 18980**  
Maintenance Kit



## RCH / RCH RS

### STURDIEST AND LIGHTEST CUTTER IN ITS CATEGORY.

For professional cutting of porcelain tiles and ceramic tiles.



  
CATEGORY: SUPERPRO

  
USE: PROFESSIONAL

  
MATERIAL: PORCELAIN TILE

  
LIGHT

  
STURDINESS











- **Enhanced visibility.** T-shaped guide allows user to see the scoring wheel from the top with minimum angle.
- **Increased stability.** Double Side Stop to for large format tiles.
- **Ultra-light weight.** The machine is full made in aluminium for enhanced transportability.
- **Straightness regulation system.**
  - One hand operated multipoint breaker with MAGNET system that increases the speed and precision in cutting. 950 Kg breaking power.
  - Die-casting slider with 4 riveted double ball bearings capable of resisting a high load.
  - Closed profile extruded aluminium guide with stainless steel raceway. Reduces both lateral and vertical bending improving cutting performance.
  - Die-cast aluminium guide supports.
  - Bi-material base Rubber.
  - Side stop for repetitive cuts at 90° and 45°.
  - Rubber wheels and handle for easy transport.
  - Reinforced textile carrying case for transport, protection and durability.
  - Supplied with Ø22 EXTREME scoring wheel.
  - RS models Supplied with reinforced fixed square with magnet fixation and 30 cm long side stop for straight repetitive cuts.



**3+1**  
YEARS  
WARRANTY

**1 2 3 4 5**  
Cut & Drill

REF.										
<b>RCH-850</b>	27924	√	334 5/8" 850 cm	23 5/8x23 5/8" 60x60 cm	1/4-3/4" 5-18 mm	2094.37 lb 950 kg	26.23474 lb 11,9 kg	31.9667 lb 14,5 kg	-	-
<b>RCH-850 RS</b>	27921		28.43934 lb 12,9 kg	34.1713 lb 15,5 kg						
<b>RCH-1200</b>	27925		472 1/2" 1200 cm	33 1/2x33 1/2" 85x85 cm			39.46234 lb 17,9 kg	46.73752 lb 21,2 kg		
<b>RCH-1200 RS</b>	27922		41.66694 lb 18,9 kg	48.94212 lb 22,2 kg						
<b>RCH-1600</b>	27926		45.85568 lb 20,8 kg	55.55592 lb 25,2 kg						
<b>RCH-1600 RS</b>	27923		48.06028 lb 21,8 kg	57.76052 lb 26,2 kg						

\*The pictures of this product might be slightly different to its final version.

#### ACCESSORIES



**REF. 18980**  
Maintenance Kit

## HIT-PLUS / HIT-PLUS RS

**FOR THE MOST DEMANDING JOBS ON ALL TYPES OF LARGE-FORMAT CERAMIC TILES.**  
For professional cutting of porcelain and ceramic tiles.



**CATEGORY: SUPERPRO**

**USE: PROFESSIONAL**

**MATERIAL: PORCELAIN TILE**

**POWER**  
900 kg



- **Slider assembly with ball bearings for greater SMOOTHNESS and COMFORT during scoring.**
- **MAGNET System. The pressure pad for scoring and breaking can be locked and unlocked with one hand. FASTER use and cutting accuracy.**
- **Full view of the scoring and cutting area thanks to the forward position of the scoring wheel in front of the pressure pad.**
- **Closed extruded aluminium structure base for greater RIGIDITY and cutting CAPACITY.**
- With HIGH performance moving breaker.
- Ground, chrome-plated solid steel guides with anti-corrosion treatment, and 25 mm diameter for greater torsional strength.
- With a square that includes a side stop for repetitive and 45° cuts.
- Equipped with 4 additional aluminium arms for working with large ceramic tiles.
- Moving guides stop for adjusting the cut to the tile dimension.
- Double tile support with accessory for cutting at 45°.
- Handle with soft grip for better ERGONOMICS and COMFORT.
- Includes articulated arms to give more support to the ceramic.
- Wide range of scoring wheels adaptable to each material (6, 8, 10, 18 and 22 mm diameter). Includes Extreme 22 mm scoring wheel.
- Equipped with 2 wheels and grip for better tool movement.
- The RS version includes a reinforced square with magnet fixing.
- The 1600 mm long versions include wheels for easier transport.
- The bag includes wheels for 1200, 1600 and 1800 option.





**SECURE LOCK SYSTEM**

Only compatible with LOCK SYSTEM SCORING WHEELS



	REF.									
HIT-1200 PLUS WITH BAG	27902	√	47 1/4" 120 cm	33 1/2x33 1/2" 85x85 cm	1/8-3/4" 3-18 mm	1984.14 lb 900 kg	45.1943 lb 20.5 kg	55.99684 lb 25.4 kg	1	20
HIT-1600 PLUS R5 WITH BAG	27903		62" 160 cm	44 1/2x44 1/2" 113x113 cm			59.5242 lb 27 kg	71.6495 lb 32.5 kg		-
HIT-1200 PLUS	27900	-	47 1/4" 120 cm	33 1/2x33 1/2" 85x85 cm			48.28074 lb 21.9 kg	56.43776 lb 25.6 kg		20
HIT-1600 PLUS	27909		62" 160 cm	39 3/8x39 3/8" 100x100 cm			48.5012 lb 22 kg	- lb - kg		24
HIT-1600 PLUS R5	27901		44 1/2x44 1/2" 113x113 cm	59.5242 lb 27 kg			- lb - kg	-		
HIT-1800 PLUS	27916		70 7/8" 180 cm	50 x50 " 127x127 cm			60.097396 lb 27.26 kg	-		

**ACCESSORIES**



**REF. 18980**  
Maintenance Kit

# HIT-N

## ROBUSTNESS AND PRECISION IDEAL FOR CUTTING PORCELAIN TILES.

For professional cutting of porcelain and ceramic tiles.



  
CATEGORY: SUPERPRO

  
USE: PROFESSIONAL

  
MATERIAL: PORCELAIN TILE

  
POWER  
800 kg



- **With high performance moving breaker.**
- **Slider assembly with ball bearings for greater smoothness and comfort during scoring.**
- **Full view of the scoring and cutting area thanks to the forward position of the scoring wheel in front of the pressure pad.**
- **Closed extruded aluminium structure base for greater rigidity and cutting capacity.**
- Ground, chrome-plated solid steel guides with anti-corrosion treatment, and 20 mm diameter for greater torsional strength.
- Guides fixed with clamps for greater rigidity.
- With side stop for repetitive and 45° cuts.
- Equipped with 4 additional aluminium arms, for large-sized ceramic tiles.
- Handle with soft grip for better ergonomics and comfort.
- Wide range of scoring wheels adaptable to each material (6, 8, 10, 18 and 22mm diameter).
- Includes 22mm scoring wheel.
- Includes articulated arms to give more support to the ceramic.



**SECURE LOCK SYSTEM**

Only compatible with LOCK SYSTEM SCORING WHEELS



	REF.									
HIT-1000 N WITH BAG	26999	√	39 3/8" 100 cm	27 1/2x27 1/2" 70x70 cm	1/8-5/8" 3-15 mm	1763.68 lb 800 kg	27.491362 lb 12.47 kg	30.8644 lb 14 kg	1	-
HIT-1200 N WITH BAG	26962		47 1/4" 120 cm	33 1/2x33 1/2" 85x85 cm			33.113092 lb 15.02 kg	35.71452 lb 16.2 kg		24
HIT-850 N	26963	-	33 1/2" 85 cm	23 5/8x23 5/8" 60x60 cm			24.69152 lb 11.20 kg	- lb - kg		28
HIT-1000 N	26992		39 3/8" 100 cm	27 1/2x27 1/2" 70x70 cm			27.491362 lb 12.47 kg	-		-
HIT-1200 N	26961		47 1/4" 120 cm	33 1/2x33 1/2" 85x85 cm			31.19509 lb 14.15 kg	24		

**ACCESSORIES**



**REF. 18980**  
Maintenance Kit



## TS-MAX

### AUTHENTIC & ORIGINAL: LIGHTWEIGHT AND FUNCTIONAL WITH HIGH PERFORMANCE BREAKER.

For professional cutting of porcelain tiles and ceramic tiles.



  
CATEGORY: SUPERPRO

  
USE: PROFESSIONAL

  
MATERIAL: STONEWARE

  
SINGLE POINT



5/8 in  
15 mm



1763.68 lb  
800 kg



- Progressive breaking system "SMART POWER" adapts to different material hardness.
- Wide base. Greater base surface for higher stability and cutting quality.
- Reinforced components for heavy duty work. High durability.
- Ergonomic handles. Maximum comfort.
- Bigger reinforced base for a higher comfort and better stability when cutting.
- Powerful single point breaker. Up to 800 kg breaking pressure.
- Double guide for direct view of scoring/cutting line.
- Chromed steel guides, rectified and calibrated, with anti-rust treatment.
- Lateral stop for repetitive straight and 45° cuts.
- Interchangeable scoring wheels ranging from Ø 6mm to 22 mm.
- Includes Ø 8mm ENDURE and Ø 10 mm SILVER scoring wheels and a transport case with reinforced locks and hinges.



**SECURE LOCK SYSTEM**

Only compatible with LOCK SYSTEM SCORING WHEELS



REF.								
<b>TS-43 MAX</b>	18920	16 7/8" 43 cm	11 3/4x11 3/4" 30x30 cm			19.40048 lb 8,8 kg		24
<b>TS-57 MAX</b>	18921	22 1/2" 57 cm	15 3/4x15 3/4" 40x40 cm			21.82554 lb 9,9 kg		24
<b>TS-66 MAX</b>	18922	25" 66 cm	18 1/8x18 1/8" 46x46 cm			29.54164 lb 13,4 kg		20
<b>TS-75 MAX</b>	18923	29 1/2" 75 cm	20 7/8x20 7/8" 53x53 cm	1/4-5/8" 6-15 mm	1763.68 lb 800 kg	33.28946 lb 15,1 kg	1	20
<b>TS-43 MAX (GREY)</b>	18972	16 7/8" 43 cm	11 3/4x11 3/4" 30x30 cm			19.40048 lb 8,8 kg		24
<b>TS-66 MAX (GREY)</b>	18974	25" 66 cm	18 1/8x18 1/8" 46x46 cm			29.54164 lb 13,4 kg		20
<b>TS-75 MAX (GREY)</b>	18975	29 1/2" 75 cm	20 7/8x20 7/8" 53x53 cm			33.28946 lb 15,1 kg		20

**ACCESSORIES**



**REF. 18980**  
Maintenance Kit

## SPEED-MAGNET

**IDEAL BALANCE BETWEEN ROBUSTNESS AND LIGHTNESS IN CERAMIC TILE CUTTING.**  
For professional cutting of porcelain tiles and ceramic tiles.



CATEGORY: SUPERPRO

USE: PROFESSIONAL

MATERIAL: STONEWARE

LIGHT



- **Quick speed system with magnet, ideal for one-handed use. Easy and fast to use.**
- **Great visibility during scoring.**
- **Reinforced structured elements. High breaking power.**
- **Aluminium base for robustness. Light and easy to transport.**
- Solid 20mm steel guides. Chromed and rectified with anti-corrosion treatment for greater resistance to twisting.
- Multipoint breaker 800kg power.
- Reinforced SOFT-GRIP handle.
- Lateral stop for repetitive cuts and 45 degrees square.
- Interchangeable scoring wheels ranging between Ø 6mm–22mm.
- Scoring wheel Ø 8mm ENDURE. included.
- Direct view of scoring and cutting line.
- 72/92 models:
- -Aluminium lateral support.



**SECURE LOCK SYSTEM**

Only compatible with LOCK SYSTEM SCORING WHEELS



	REF.									
<b>SPEED-62 MAGNET WITH CASE</b>	14988	√	24 3/8" 62 cm	17 3/8x17 3/8" 44x44 cm	1/8-5/8" 3-15 mm	1763.68 lb 800 kg	17.6368 lb 8 kg	25.3529 lb 11.5 kg	2	24
<b>SPEED-72 MAGNET WITH CASE</b>	14989		28 3/8" 72 cm	20 1/8x20 1/8" 51x51 cm			20.9437 lb 9.5 kg	29.98256 lb 13.6 kg		
<b>SPEED-92 MAGNET WITH CASE</b>	14990		36 1/4" 92 cm	25 5/8x25 5/8" 65x65 cm			26.4552 lb 12 kg	37.03728 lb 16.8 kg	1	
<b>SPEED-62 MAGNET</b>	14980	-	24 3/8" 62 cm	17 3/8x17 3/8" 44x44 cm			17.6368 lb 8 kg	- lb - kg	2	30
<b>SPEED-72 MAGNET</b>	14981		28 3/8" 72 cm	20 1/8x20 1/8" 51x51 cm			20.9437 lb 9.5 kg			
<b>SPEED-92 MAGNET</b>	14982		36 1/4" 92 cm	25 5/8x25 5/8" 65x65 cm			26.4552 lb 12 kg		1	

**ACCESSORIES**



**REF. 18980**  
Maintenance Kit

## SPEED-N

### THE MOST VERSATILE TILE CUTTER IN IT'S RANGE.

For professional cutting of ceramic tiles, occasionally for porcelain tiles.



  
CATEGORY: PRO

  
USE: PROFESSIONAL

  
MATERIAL: STONEWARE









  
STURDINESS



- **Reinforced structured elements. High breaking power.**
- **Chromed and rectified steel guides, with anticorrosion treatment. Higher durability.**
- **Aluminium base for higher robustness.**
- **Light and easy to transport.**
  - With lateral stop for repetitive cuts and 45 degree squares.
  - Interchangeable scoring wheels ranging between Ø 6mm to 10mm.
  - Scoring wheel Ø 8 mm SILVER included.
  - Direct vision of scoring and cutting line.
- 72/92 models;
- -Aluminium lateral support.





	REF.								
<b>SPEED-62 N WITH CASE</b>	14985	√	24 3/8" 62 cm	17 3/8x17 3/8" 44x44 cm	1/4-5/8" 5-15 mm	15.4322 lb 7 kg	23.36876 lb 10,6 kg	2	24
<b>SPEED-72 N WITH CASE</b>	14986		28 3/8" 72 cm	20 1/8x20 1/8" 51x51 cm		18.07772 lb 8,2 kg	27.5575 lb 12,5 kg		18
<b>SPEED-92 N WITH CASE</b>	14987		36 1/4" 92 cm	25 5/8x25 5/8" 65x65 cm		24.2506 lb 11 kg	35.05314 lb 15,9 kg	1	
<b>SPEED-62 N</b>	14975	-	24 3/8" 62 cm	17 3/8x17 3/8" 44x44 cm		15.4322 lb 7 kg	23.36876 lb 10,6 kg	2	30
<b>SPEED-72 N</b>	14976		28 3/8" 72 cm	20 1/8x20 1/8" 51x51 cm		18.07772 lb 8,2 kg	27.5575 lb 12,5 kg		1
<b>SPEED-92 N</b>	14977		36 1/4" 92 cm	25 5/8x25 5/8" 65x65 cm		24.2506 lb 11 kg	35.05314 lb 15,9 kg	28	

## ACCESSORIES



**REF. 18980**  
Maintenance Kit

FAST

**LIGHT AND VERSATILE CUTTER.**

For professional cutting of ceramic tiles.



  
CATEGORY: PRO

  
USE: PROFESSIONAL

  
MATERIAL: STONEWARE

VERSATILITY

1/2 in  
12 mm

- **Extruded aluminium base.**
- **New rigid and stable separator.**
- **Reinforced 18mm guides for greater resilience.**
- **Four side brackets for a great additional support.**
- Wider foam base.
- Chromed steel guides with anti-rust treatment.
- Lateral stop with 45° square.
- Base for greater support of the tile.
- Interchangeable scoring wheels from Ø1/4" (6mm) to 11/16" (18mm).
- Ø1/4" (6mm) SILVER scoring wheel included.
- Two-layer base with shock absorption.
- Direct view of the scoring and cutting line.



**SECURE LOCK SYSTEM**

Only compatible with LOCK SYSTEM SCORING WHEELS



	REF.								
<b>FAST-85 WITH BAG</b>	13939	√	33 1/2" 85 cm	23 5/8x23 5/8" 60x60 cm	1/2" 12 mm	16.5345 lb 7.5 kg	18.7391 lb 8.5 kg	2	32
<b>FAST-65</b>	13940	-	25 5/8" 65 cm	17 3/4x17 3/4" 45x45 cm		13.88898 lb 6.3 kg	- lb - kg	4	48
<b>FAST-85</b>	13941	-	33 1/2" 85 cm	23 5/8x23 5/8" 60x60 cm		16.5345 lb 7.5 kg	- lb - kg	2	32

**ACCESSORIES**



**REF. 18980**  
Maintenance Kit



## STAR PLATINUM

### LIGHT AND VERSATILE CUTTER.

For professional cutting of ceramic tiles, occasionally for porcelain tiles.



  
CATEGORY: PRO

  
USE: PROFESSIONAL

  
MATERIAL: STONEWARE

  
LIGHT



- Multipoint breaker with aluminium pressure pad and steel breaker bar for greater **ROBUSTNESS** and breaking **POWER**.
- Aluminium tool holder, more **RIGID** and **STABLE** for **EASIER** tile scoring.
- Cast aluminium base, **LIGHT** and **STRONG** with side extensions for large pieces.
- Cast **ALUMINIUM** guide supports for greater **ROBUSTNESS**.
- Dual guide for greater **VISIBILITY** of the scoring and cutting line.
- Solid, chromed, ground and calibrated steel guides with anti-corrosion treatment.
- Side stop with millimetre scale and 45° square.
- Interchangeable scoring wheels from Ø1/4" (6mm) to 3/8" (10mm).
- Ø 6 mm **SILVER** scoring wheel included.



**3+1**  
YEARS  
WARRANTY

**1 2 3 4 5**  
Cut & Drill

	REF.								
<b>STAR-63 PLATINUM WITH CASE</b>	15904	✓	24 3/4" 63 cm	17 3/4x17 3/4" 45X45 cm		9.678194 lb 4.39 kg	13.315784 lb 6.04 kg	4	48
<b>STAR-51 PLATINUM</b>	15901	-	20 1/8" 51 cm	14 1/8x14 1/8" 36X36 cm	1/2" 12 mm	8.289296 lb 3.76 kg	- lb - kg	6	-
<b>STAR-63 PLATINUM</b>	15902	-	24 3/4" 63 cm	17 3/4x17 3/4" 45X45 cm		9.678194 lb 4.39 kg	- lb - kg	6	72

**ACCESSORIES**



**REF. 18980**  
Maintenance Kit



## STAR

**LIGHT AND VERSATILE CUTTER.**

For occasional cutting of ceramic tile and cutting of porcelain tiles.

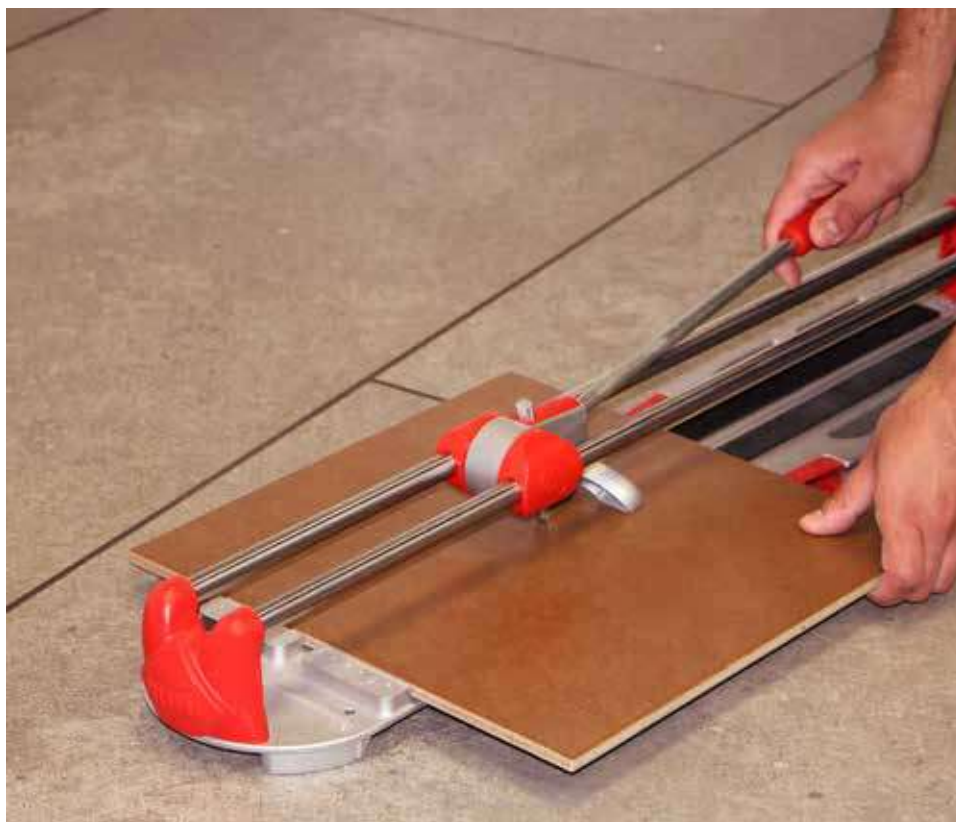

CATEGORY: PRO



USE: OCCASIONAL



MATERIAL: STONEWARE



RELIABILITY



PROTECTED  
DESIGN

- **Closed sliding mobile breaker for greater bending strength.**
- **New support reinforced for durability and power separation.**
- **Chromed steel guides with anti-rust treatment for greater durability.**
- **Base for correct support of the tile.**
  - Interchangeable scoring wheels from Ø1/4" (6mm) to 3/8" (10mm).
  - Ø1/4" (6mm) SILVER scoring wheel included.
  - Two-layer base with shock absorption.
  - Direct view of the scoring and cutting line.



	REF.								
<b>STAR-42 WITH CASE</b>	14946	√	16 1/2" 42 cm	11 3/4x11 3/4" 30x30 cm	1/2" 12 mm	749564 lb 3,4 kg	10.58208 lb 4,8 kg	4	48
<b>STAR-51 WITH CASE</b>	14947		20 1/8" 51 cm	14 1/8x14 1/8" 36x36 cm		8.15702 lb 3,7 kg	12.34576 lb 5,6 kg		
<b>STAR-63 WITH CASE</b>	14948		24 3/4" 63 cm	17 3/4x17 3/4" 45x45 cm		9.47978 lb 4,3 kg	14.32999 lb 6,5 kg		
<b>STAR-42</b>	14943	-	16 1/2" 42 cm	11 3/4x11 3/4" 30x30 cm		749564 lb 3,4 kg	- lb - kg	6	72
<b>STAR-51</b>	14944		20 1/8" 51 cm	14 1/8x14 1/8" 36x36 cm		8.15702 lb 3,7 kg			
<b>STAR-63</b>	14945		24 3/4" 63 cm	17 3/4x17 3/4" 45x45 cm		9.47978 lb 4,3 kg			

ACCESSORIES



REF. 18980  
Maintenance Kit



# PRACTIC

**IDEAL FOR SMALL RENOVATIONS AND LIGHT WORK.**  
For occasional cutting ceramic wall and floor tiles.



- **Movable breaker, ideal for diagonal cuts.**
- **Aluminium guide supports for greater rigidity.**
- **Lateral end stop for repetitive cuts.**
- **Interchangeable scoring wheels to adapt to each material.**
- Chromed steel guides and aluminium support.
- Mobile breaker with Ø1/4"(6mm) SILVER scoring wheel included.
- Interchangeable scoring wheels Ø1/4"(6mm) to 3/8"(10mm) for cutting different materials.

**CATEGORY: PRO**

**USE: OCCASIONAL**

**MATERIAL: STONEWARE**

**LIGHT**

	REF.						
<b>PRACTIC-51</b>	24984	20 1/8" 51 cm	14 1/8x14 1/8" 36x36 cm	3/8" 10 mm	6.39334 lb 2.9 kg	6	72
<b>PRACTIC-61</b>	24985	24 1/8" 61 cm	16 7/8x16 7/8" 43x43 cm		10.80254 lb 4.9 kg		

**ACCESSORIES**



**REF. 18980**  
Maintenance Kit



# BASIC

## IDEAL FOR SMALL RENOVATIONS AND LIGHT WORK.

For occasional cutting ceramic floor tiles.



- Base, guide & supports in steel and aluminium.
- Mobile breaker and Ø9/16"(14mm) SILVER Tungsten Carbide scoring wheel included.
- Also comes with lateral stop and 45° square.

**CATEGORY: PRO**

**USE: OCCASIONAL**

**MATERIAL: CERAMIC TILE**

	REF.						
<b>BASIC-60</b>	25956	24 1/8" 61 cm	16 7/8x16 7/8" 43x43 cm	3/8" 10 mm	7.7161 lb 3.5 kg	6	72





### ACCESSORIES



**REF. 18980**  
Maintenance Kit

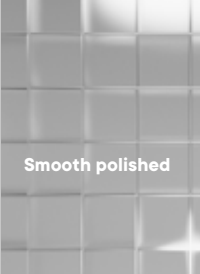

# SCORING WHEELS

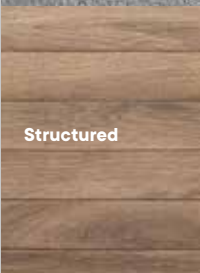
TILE SURFACE	TILE TYPE			
	CERAMIC WALL BIII	CERAMIC FLOOR BIIa - BIIb	PORCELAIN BIIa	QUARRY AI - AIIa - AIIb - AIII
 <p>Smooth polished</p>	6 mm • ¼" Silver* 8 mm • ⅝" Silver/Endure 10 mm • ¾" Silver/Gold 18 mm • ¾" Silver		6 mm • ¼" Silver 8 mm • ⅝" Silver/Endure* 10 mm • ¾" Silver/Gold 18 mm • ¾" Silver	
 <p>Smooth Matt</p>	6 mm • ¼" Silver* 8 mm • ⅝" Silver/Endure 10 mm • ¾" Silver/Gold 18 mm • ¾" Silver 22 mm • ⅞" Silver/Extreme	6 mm • ¼" Silver 8 mm • ⅝" Silver/Endure 10 mm • ¾" Silver/Gold* 18 mm • ¾" Silver 22 mm • ⅞" Silver/Extreme	6 mm • ¼" Silver 8 mm • ⅝" Silver/Endure* 10 mm • ¾" Silver/Gold 18 mm • ¾" Silver 22 mm • ⅞" Silver/Extreme	8 mm • ⅝" Silver/Endure 10 mm • ¾" Silver/Gold 18 mm • ¾" Silver* 22 mm • ⅞" Silver/Extreme
 <p>Textured</p>	8 mm • ⅝" Silver/Endure* 18 mm • ¾" Silver 22 mm • ⅞" Silver/Extreme	8 mm • ⅝" Silver/Endure 18 mm • ¾" Silver* 22 mm • ⅞" Silver/Extreme	8 mm • ⅝" Silver/Endure 18 mm • ¾" Silver* 22 mm • ⅞" Silver/Extreme	18 mm • ¾" Silver* Extreme
 <p>Highly textured</p>	8 mm • ⅝" Endure 18 mm • ¾" Silver 22 mm • ⅞" Extreme*	8 mm • ⅝" Endure 18 mm • ¾" Silver 22 mm • ⅞" Extreme*	8 mm • ⅝" Endure 18 mm • ¾" Silver 22 mm • ⅞" Extreme*	18 mm • ¾" Silver 22 mm • ⅞" Extreme*
 <p>Structured</p>	8 mm • ⅝" Endure 18 mm • ¾" Silver 22 mm • ⅞" Extreme*	8 mm • ⅝" Endure 18 mm • ¾" Silver 22 mm • ⅞" Extreme*	8 mm • ⅝" Endure 18 mm • ¾" Silver 22 mm • ⅞" Extreme*	18 mm • ¾" Silver 22 mm • ⅞" Extreme*

\* Recommended



		△ PRO								△ SUPERPRO				△ PREMIUM		
		SILVER								GOLD		ENDURE		EXTREME		
		1945	1958	1959	1946	1991	1960	1950	1992	1949	1993	1906	1903	1901	1907	1900
Refs:	6	8	8	10	10	14	18	18	10	10	8	8	22	22	22	
Ø mm:	¼	⅝	⅝	¾	¾	⅞	⅞	¾	¾	¾	⅝	⅝	⅞	⅞	⅞	
Ø inch:			PLUS		PLUS			PLUS		PLUS		PLUS			PLUS	
△ PREMIUM ●●● Intensive	TZ			○				○			○		○			○
	TK			○				○			○		○			○
	TX MAX			○				○			○		○			○
△ SUPERPRO ●●● Professional	TP												○			
	TR MAGNET	○	○		■			○		○		○		○	■	
	RCH RS												○			
	RCH												○			
	HIT PLUS RS	○	○		○			○		○		○		○	■	
	HIT PLUS	○	○		○			○		○		○		○	■	
	HIT N	○	○		○			○		○		○		○	■	
	TS MAX	○	○		■			○		○		○		○	■	
	SPEED MAGNET	○	○		○			○		○		○		○	■	
	△ PRO ●●● Occasional	SPEED N	○	○		○					○		○			
FAST		○	○		○			○		○		○		○		
STAR PLATINUM		○	○		○					○		○				
STAR		○	○		○					○		○				
PRACTIC		○	○		○					○		○				
BASIC								○								

■ Included

# PREMIUM SCORING WHEELS

• PLUS SCORING WHEELS FOR TX-MAX, TK & TZ PROFESSIONAL CUTTERS.

**PATENTED**



CATEGORY:  
PRO

SILVER



## 8MM PLUS SILVER SCORING WHEEL

- For ceramic wall, ceramic floor and porcelain, ideal for tiles with smooth and slightly textured surfaces.
- Tungsten carbide scoring wheel of high resistance and durability.
- Patented geometry shaft, for maximum precision and minimum vibration.

REF.



8 MM PLUS SCORING WHEEL SILVER	01959	10	3600

CATEGORY:  
SUPERPRO

ENDURE



## 8MM PLUS SCORING WHEEL (Ø5/16") ENDURE

- For ceramic wall, ceramic floor, porcelain and rustic ceramic floor, ideal for smooth, textured and Highly textured surfaces.
- Wheel made of tungsten carbide.
- Patented geometry shaft, for maximum precision and minimum vibration.
- Extra-long life.

REF.



8MM PLUS SCORING WHEEL (Ø5/16") ENDURE	01903	10	-

CATEGORY:  
PRO

SILVER



## 10MM PLUS SILVER SCORING WHEEL (Ø3/8")

- For ceramic wall, ceramic floor, porcelain and rustic ceramic floor, ideal for smooth and slightly textured surfaces.
- Tungsten carbide scoring wheel of high resistance and duration.
- Shaft made with a patented geometry for a maximum precision and minimum vibration.

REF.



10 MM PLUS SCORING WHEEL	01991	10	3600

CATEGORY:  
SUPERPRO

GOLD



## 10MM PLUS GOLD SCORING WHEEL (Ø13/32")

- For ceramic wall, ceramic floor, porcelain and rustic ceramic floor, ideal for non-slip surfaces.
- Tungsten carbide scoring wheel with a superficial titanium treatment.
- Shaft made with a patented geometry for a maximum precision and minimum vibration.
- Long-lasting.

REF.



10MM PLUS GOLD SCORING WHEEL (Ø13/32")	01993	10	3600

CATEGORY:  
PRO

SILVER



## 18MM PLUS SILVER SCORING WHEEL (Ø3/4")

- For ceramic wall, ceramic floor, porcelain and rustic ceramic floor, ideal for Highly textured.
- Tungsten carbide scoring wheel of high resistance and duration.
- Shaft made with a patented geometry for a maximum precision and minimum vibration.

REF.



18 MM PLUS SCORING WHEEL	01992	10	3600

CATEGORY:  
PREMIUM

EXTREME



### 22MM SCORING WHEEL PLUS EXTREME(Ø 7/8")

- For ceramic walls, ceramic floor, porcelain and rustic ceramic floor, ideal for Highly textured and structured surfaces.
- Tungsten carbide scoring wheel with a superficial titanium treatment.
- Mounted on bearing. Enhanced smooth user perception.
- Extra-long life.

REF.



22MM SCORING WHEEL PLUS EXTREME (Ø 7/8")

01900

10

-

## SUPERPRO SCORING WHEELS

- ADAPTABLE SCORING WHEEL FOR TP, TQ & RCH PROFESSIONAL CUTTERS.

**2**  
Cut & Drill

CATEGORY:  
PREMIUM

EXTREME



### 22MM SCORING WHEEL PLUS EXTREME (Ø 7/8") TP/TQ/RCH/SLAB CUTTER

- For sharp cuttings in hard ceramic and porcelain tiles.
- Tungsten Carbide scoring wheel with a superficial Titanium treatment.
- Mounted on bearing. Enhanced smooth user perception.
- Extra-long life.

REF.



22MM SCORING WHEEL PLUS EXTREME (Ø 7/8") TP/TQ/  
RCH/SLAB CUTTER

01901

5

-



# SUPERPRO SCORING WHEELS

- FOR TS-MAX, TR-MAGNET, HIT, HIT-PLUS, HIT-PLUS RS & SPEED-MAGNET CUTTERS.

**PATENTED**



CATEGORY: PRO SILVER



## 6MM SILVER SCORING WHEEL (Ø1/4")

- For ceramic wall, ceramic floor and porcelain, ideal for tiles with smooth and slightly textured surfaces.
- Tungsten carbide scoring wheel of high resistance and durability.
- Lock system patented model with new high technology RUBI® alloy; maximum precision and resistant to wear.

	REF.		
6MM SCORING WHEEL (Ø1/4") SILVER	01945	10	4400

CATEGORY: PRO SILVER



## 8MM SILVER SCORING WHEEL (Ø5/16")

- For ceramic wall, ceramic floor, porcelain and rustic ceramic floor, ideal for smooth and slightly textured surfaces.
- Tungsten carbide scoring wheel of high resistance and durability.
- Lock system patented model with new high technology RUBI® alloy; maximum precision and resistant to wear.

	REF.		
8MM SCORING WHEEL (Ø5/16") SILVER	01958	10	4400

CATEGORY: SUPERPRO ENDURE



## 8MM ENDURE SCORING WHEEL (Ø5/16")

- For ceramic wall, ceramic floor, porcelain and rustic ceramic floor, ideal for smooth, textured and Highly textured surfaces.
- Wheel made of tungsten carbide.
- Lock system patented geometry shaft, for maximum precision and minimum vibration.
- Extra-long life.

	REF.		
8MM SCORING WHEEL (Ø5/16") ENDURE	01906	10	-

CATEGORY: PRO SILVER



## 10MM SILVER SCORING WHEEL (Ø3/8")

- For ceramic wall, ceramic floor, porcelain and rustic ceramic floor, ideal for smooth and slightly textured surfaces.
- Tungsten carbide scoring wheel of high resistance and durability.
- Lock system patented handle made with new high technology RUBI® alloy; maximum precision and resistant to wear.

	REF.		
10MM SCORING WHEEL (Ø3/8") SILVER	01946	10	4400

CATEGORY: SUPERPRO GOLD



## 10MM GOLD SCORING WHEEL (Ø3/8")

- For ceramic wall, ceramic floor, porcelain and rustic ceramic floor, ideal for non-slip surfaces.
- Tungsten carbide scoring wheel with a superficial titanium treatment.
- Lock system patented handle made with new high technology RUBI® alloy; maximum precision and resistant to wear. Long-lasting.

	REF.		
SCORING WHEEL Ø3/8" (10MM) GOLD	01949	10	4400



CATEGORY:  
PRO

SILVER



### 18MM SILVER SCORING WHEEL (Ø3/4")

- For ceramic wall, ceramic floor, porcelain and rustic ceramic floor, ideal for Highly textured.
- Tungsten carbide scoring wheel of high resistance and durability.
- Lock system patented shaft geometry; maximum precision and minimum vibration.
- Compatible with FAST cutters.

	REF.		
SCORING WHEEL Ø3/4" (18MM) SILVER	01950	10	3600

CATEGORY:  
PREMIUM

EXTREME



### 22MM SCORING WHEEL (Ø7/8") EXTREME

- For ceramic walls, ceramic floor, porcelain and rustic ceramic floor, ideal for Highly textured and structured surfaces.
- Tungsten carbide scoring wheel with a superficial titanium treatment.
- Patented lock system geometry shaft, for maximum precision and minimum vibration.
- Patented model for maximum precision and minimum vibration.
- Extra-long life.
- Compatible with FAST cutters.

	REF.		
SCORING WHEEL Ø7/8" (22MM) EXTREME	01907	10	-

CATEGORY:  
PRO

SILVER



### 6MM SILVER SCORING WHEEL SET (Ø1/4")

- Tungsten carbide scoring wheel of high resistance and durability.
- Shaft made with a patented geometry for a maximum precision and minimum vibration.
- Shaft made patented lock system with new high technology RUBI® alloy; maximum precision and resistant to wear.

	REF.		
6MM SCORING WHEEL SET (Ø 1/4") SILVER	01947	10	4400



CATEGORY:  
PRO

SILVER



### 6MM (Ø1/4") & 10MM (Ø3/8") SCORING WHEELS SET

- Tungsten carbide scoring wheel of high resistance and durability.
- Shaft made patented lock system with new high technology RUBI® alloy; maximum precision and resistant to wear.

	REF.		
6MM (Ø1/4") & 10MM (Ø3/8") SILVER SCORING WHEELS SET	01948	10	3600



## SCORING WHEEL SETS

- SETS OF SCORING WHEELS OF DIFFERENT DIAMETERS WITH BOX.



CATEGORY:  
PRO

SILVER

### SCORING WHEEL SET 2



- For TS-MAX, TR-MAGNET, TF-MAX & SPEED-MAGNET models, includes 1 scoring wheel of  $\text{Ø}1/4''$  (6mm).
- $\text{Ø}5/16''$  (8mm),  $\text{Ø}3/8''$  (10mm),  $\text{Ø}7/8''$  (18mm) (2 units) SILVER.
- In plastic box with transparent cover.
- Supplied in blister.

	REF.		
SCORING WHEEL SET 2	01996	5	450

## PRO SCORING WHEELS

- SELECTION OF SCORING WHEELS FOR SPEED-N, FAST, STAR-MAX, STAR, POCKET & PRACTIC MANUAL CUTTERS.

PATENTED



CATEGORY:  
PRO

SILVER

### 6MM SILVER SCORING WHEEL (Ø1/4")



- For ceramic wall, ceramic floor and porcelain, ideal for tiles with smooth and slightly textured surfaces.
- Tungsten carbide scoring wheel of high resistance and durability.
- Lock system patented model with new high technology RUBI® alloy; maximum precision and resistant to wear.

	REF.		
6MM SCORING WHEEL (Ø1/4") SILVER	01945	10	4400

CATEGORY:  
PRO

SILVER

### 8MM SILVER SCORING WHEEL (Ø5/16")



- For ceramic wall, ceramic floor, porcelain and rustic ceramic floor, ideal for smooth and slightly textured surfaces.
- Tungsten carbide scoring wheel of high resistance and durability.
- Lock system patented model with new high technology RUBI® alloy; maximum precision and resistant to wear.

	REF.		
8MM SCORING WHEEL (Ø5/16") SILVER	01958	10	4400

CATEGORY:  
SUPERPRO

ENDURE

### 8MM ENDURE SCORING WHEEL (Ø5/16")



- For ceramic wall, ceramic floor, porcelain and rustic ceramic floor, ideal for smooth, textured and Highly textured surfaces.
- Wheel made of tungsten carbide.
- Lock system patented geometry shaft, for maximum precision and minimum vibration.
- Extra-long life.

	REF.		
8MM SCORING WHEEL (Ø5/16") ENDURE	01906	10	-





CATEGORY:  
PRO

SILVER



### 10MM SILVER SCORING WHEEL (Ø3/8")

- For ceramic wall, ceramic floor, porcelain and rustic ceramic floor, ideal for smooth and slightly textured surfaces.
- Tungsten carbide scoring wheel of high resistance and durability.
- Lock system patented handle made with new high technology RUBI® alloy; maximum precision and resistant to wear.

	REF.		
10MM SCORING WHEEL (Ø3/8") SILVER	01946	10	4400

CATEGORY:  
PRO

SILVER



### 6MM SILVER SCORING WHEEL SET (Ø1/4")

- Tungsten carbide scoring wheel of high resistance and durability.
- Shaft made with a patented geometry for a maximum precision and minimum vibration.
- Shaft made patented lock system with new high technology RUBI® alloy; maximum precision and resistant to wear.

	REF.		
6MM SCORING WHEEL SET (Ø 1/4") SILVER	01947	10	4400

CATEGORY:  
PRO

SILVER



### 6MM (Ø1/4") & 10MM (Ø3/8") SCORING WHEELS SET

- Tungsten carbide scoring wheel of high resistance and durability.
- Shaft made patented lock system with new high technology RUBI® alloy; maximum precision and resistant to wear.

	REF.		
6MM (Ø1/4") & 10MM (Ø3/8") SILVER SCORING WHEELS SET	01948	10	3600



CATEGORY:  
PRO

SILVER



### 14MM SILVER SCORING WHEEL (Ø9/16")

- For BASIC, KIT and TEN-BRIC tile cutters.
- Wheel made of Tungsten Carbide.

	REF.		
14MM SILVER SCORING WHEEL (Ø9/16")	01960	10	4600



## ACCESSORIES FOR MANUAL TILE CUTTERS

**2**  
Cut & Drill

 CATEGORY:  
SUPERPRO

### MAINTENANCE KIT

- Cleaning, lubricating & maintenance oil suitable for regular maintaining of cutter parts that are regularly used; guides, sliding system, tilted axes, spiral, metallic surfaces.

	REF.		
MAINTENANCE KIT	18980	8	640

## NIPPERS

- WIDE RANGE OF PLIERS FOR CUTTING CERAMICS, PORCELAIN & GLASS.

**2**  
Cut & Drill

 CATEGORY:  
SUPERPRO

### NIPPERS FOR PORCELAIN TILES

- Specially for cutting narrow strips of a maximum of 7/16" (1 cm). Equipped with tungsten carbide GOLD scoring wheels with titanium surface treatment for longer useful life. By means of a gentle turn, the wheels can be repositioned when their vertex starts getting worn. If totally worn, they can be replaced using their corresponding spare piece, Ø 3/4" (18 mm) GOLD spare scoring wheel long-life (Ref.01953).

	REF.		
NIPPERS FOR PORCELAIN TILES	83942	5	765

 CATEGORY:  
SUPERPRO

### NIPPERS FOR CERAMIC TILES

- Tungsten Carbide Edge.
- Ideal for the rectification of straight cut on ceramics.
- Bi-material handle Ergonomic.



	REF.		
NIPPERS FOR CERAMIC TILES	65926	6	-

**CATEGORY:  
SUPERPRO**



### NIPPERS FOR GLASS MOSAIC

- Tungsten Carbide Edge.
- Ideal for the rectification of glass mosaic tiles.
- Bi-material handle Ergonomic.

	REF.		
NIPPERS FOR GLASS MOSAIC	71970	5	-

**CATEGORY:  
SUPERPRO**



### TILER NIPPERS

- Tungsten Carbide Pliers.
- Ideal for rectification of holes in ceramics.
- Bi-material handle Ergonomic.

	REF.		
PARROT NIPPERS	65925	5	765

## MANUAL CUTTERS FOR BUILDING MATERIALS

• FOR DIFFERENT TYPES OF BUILDING MATERIALS.

  
 Cut & Drill

**CATEGORY:  
SUPERPRO**



### CELLULAR CONCRETE SAW

- Saw with 29 Tungsten Carbide teeth.
- Length: 29" (75cm).
- Beechwood and varnished handle.

	REF.		
CELLULAR CONCRETE SAW	70930	2	-



# SLAB SYSTEM

## CUTTING AND HANDLING LARGE-SIZED TILE

---

Cutting large tile  
Handling large tile  
Installing large tile



## SLAB CUTTER G3

### MANUAL CUTTING SYSTEM WITH CONNECTABLE GUIDES.

For manual cutting of large porcelain tiles.



CATEGORY: PREMIUM



USE: INTENSIVE



PRECISION

SCORING WHEEL POWER



125 in  
320 cm



1/8-5/8 in  
3-10 mm



7/8 in  
22 mm



- **System with movable suction cups integrated in the guides. Special grey rubber suction cups for rough surfaces that won't leave marks on the tile.**
- **Carriage with lever mechanism for perfect scoring. Extreme roller guide.**
- **Highly reinforced guides. Easily interconnected by means of an adjustable lever mechanism.**
- **Transport bag with padded handles and pockets for accessories.**
- Breaking system by adjustable nippers with soft-grip handle, which facilitates and ensures progressive breaking of the tile, thus reducing the risk of cracking. 2-in-1 nippers and breaker.
- Ø 22 mm RUBI EXTREME roller guide made of Tungsten Carbide with Titanium Carbide treatment and bearings, to offer better scoring performance and quality.
- Each set contains: Three 112 cm guides, 1 marker carriage with 22 mm roller guide, 1 set of nippers and 6 suction cups.
- Transport bag with padded handles and pockets for accessories.



	REF.							
<b>SLAB CUTTER G3</b>	16900	√	125 " 320 cm	1/8-1/2" 3-12 mm	24.2506 lb 11 kg	37.4782 lb 17 kg	1	9

The Slab Breaker Plus (ref. 18917) must be used for thicknesses from 10 mm to 20 mm.

ACCESSORIES		REF. 18917 Slab Breaker Plus		REF. 16929 Angle grinder accessory G3		REF. 28916 Slab Pliers
-------------	--	---------------------------------	--	---	--	---------------------------



## SLIM CUTTER G2

### HAND CUTTING SYSTEM WITH CONNECTABLE GUIDES.

For hand cutting of large porcelain tiles with thicknesses between 3 and 10 mm.



  
CATEGORY: SUPERPRO

  
USE: PROFESSIONAL

  
PRECISION

  
LIGHT



- **High-scoring power thanks to the new tilting carriage design and its fixing on the reinforced guides.**
- **Maximum 360 cm cutting capacity (extendable) thanks to its connectable guides. Allows a 120 cm cut with a single guide.**
- **Excellent fixing of the guides on the tile by means of 3 natural rubber suction cups, suitable for rough surfaces, with double anchoring point.**
- **It prevents tile breakage by means of the progressive breaking system of the adjustable nippers with soft-grip handle. 2-in-1 nippers and breaker.**
- Recommended thicknesses between 3 and 10 mm.
- Specially designed for large tiles, it provides a perfect cut without chipping with a light and easy-to-store cutter.
- High durability of the 22 mm RUBI EXTREME scoring wheel. Manufactured in tungsten carbide with tungsten carbide treatment and bearings, it offers better performance and high scoring quality.
- Easily transportable. It includes two practical reinforced transport bags with compartments, handles and a shoulder strap. These can be transported separately or together with the use of a simple connecting system.
- Each set contains: Two 155 cm guides, one 65 cm guide, 1 marker carriage with 22 mm roller guide, 1 set of nippers, 3 suction cups, 1 Allen key and 2 transport bags.





**3+2**  
YEARS  
WARRANTY

**1 2 3 4 5**  
Cut & Drill

	REF.						
<b>SLIM CUTTER G2</b>	23999	√	141 3/4" 360 cm	3/8" 10 mm	22.70738 lb 10.3 kg	1	-

ACCESSORIES		REF. 18917 Slab Breaker Plus		Slim Cutter G2 Supplement Guides		TC-125 G2 circular cutter kit



## TC-125 G2 CIRCULAR CUTTER KIT

### THE LIGHT AND PRECISE LARGE FORMAT CUTTER

For cutting ceramic and porcelain tiles. Suitable for use with natural and synthetic stone. Especially suitable for large format tiles.



  
CATEGORY: SUPERPRO

  
USE: PROFESSIONAL

  
MITRE CUT (45°)

DRY AND WET CUT



PROTECTED  
DESIGN

- Includes a set of suction cups suitable for all surfaces for fixing the guide to the part.
- Equipped with a carbon steel slide on adjustable double set stainless steel radial bearings.
- Double dust reduction/control system. Dry and wet cutting.
- Height-adjustable cutting head (saw effect), hinged from 0° to 45°. (mitre). FAST adjustment system.
- More ergonomic. Additional BI-MATERIAL handle, mainly for mitre cuts.
- Compatible with discs of 125 or 115 mm diameter. (Suitable for discs with reinforcement plate).
- Switch with SAFETY lock. Prevents UNINTENTIONAL start-up. Electrical cable with PRCD.
- Direct connection to vacuum cleaner. Includes adapter for other models and brands (37, 42 and 50 mm diameter).
- Quick connection and regulating valve for hose (16 mm diameter). Rubber stopper for suction outlet. IMPROVES ergonomics during wet cutting.
- Cast aluminium disc protector with transparent polycarbonate cover with quick opening and closing system. FACILITATES disc change and MINIMISES the projection of particles and water.
- Tilting side guard for mitre cuts. REDUCES water splashing and IMPROVES dust suction.
- Each set contains: 2 155 cm guides, 1 65 cm guide, 1 TC-125 cutter, 1 Ø125 disc, 2 fixing suction cups, 2 clamps, 2 spacers, 2 plates for reinforced discs (normal and thin), 1 vacuum cleaner adapter, 1 carry case and 1 carrying bag. FACILITATES transport and handling.



REF.   RPM **W**         

TC-125 G2 CIRCULAR CUTTER KIT 220-240V 50-60Hz															
TC-125 G2	51951	√	220-240V 50-60Hz	11300	1250 1250 W	∞° ∞ cm	3/4-" 20-25 mm	1/2-3/4" 14-18 mm	4 1/2-4 7/8" 115-125 mm	7/8" 22.2 mm	14 1/8x9 5/8x8 1/4" 36x24.5x21 cm	22.046 lb 10 kg	1	16	
SET OF GUIDES FOR TC-125 G2	51949	√				125° 320 cm						29.7621 lb 13.5 kg	1	24	
TC-125 G2 CIRCULAR CUTTER KIT 220-240V 50-60Hz															
TC-125 G2 UK	51967	√	220-240V 50-60Hz	11300	1250 1250 W	∞° ∞ cm	3/4-" 20-25 mm	1/2-3/4" 14-18 mm	4 1/2-4 7/8" 115-125 mm	7/8" 22.2 mm	14 1/8x9 5/8x8 1/4" 36x24.5x21 cm	22.046 lb 10 kg	1	-	
SET OF GUIDES FOR TC-125 G2	51949	√				125° 320 cm						29.7621 lb 13.5 kg	1	24	
TC-125 G2 CIRCULAR CUTTER KIT 110-130V 50-60Hz															
TC-125 G2 USA	51977	√	110-130V 50-60Hz	11300	1250 1250 W	∞° ∞ cm	3/4-" 20-25 mm	1/2-3/4" 14-18 mm	4 1/2-4 7/8" 115-125 mm	7/8" 22.2 mm	14 1/8x9 5/8x8 1/4" 36x24.5x21 cm	22.046 lb 10 kg	1	-	
SET OF GUIDES FOR TC-125 G2	51949	√				125° 320 cm						29.7621 lb 13.5 kg	1	24	
TC-125 G2 CIRCULAR CUTTER KIT 110-130V 50-60Hz															
TC-125 G2 UK	51987	√	110-130V 50-60Hz	11300	1250 1250 W	∞° ∞ cm	3/4-" 20-25 mm	1/2-3/4" 14-18 mm	4 1/2-4 7/8" 115-125 mm	7/8" 22.2 mm	14 1/8x9 5/8x8 1/4" 36x24.5x21 cm	22.046 lb 10 kg	1	-	
SET OF GUIDES FOR TC-125 G2	51949	√				125° 320 cm						29.7621 lb 13.5 kg	1	24	

The kit is a cutter reference plus the guide reference (Ref51949).  
It must be used with the SLIM SYSTEM G2 guides.

## ACCESSORIES



**REF.**  
Slim Cutter G2  
Supplement Guides



**REF. 27911**  
Slim Cutter G2 Head



**REF. 28916**  
Slab Pliers

# ANGLE GRINDER ACCESSORY G3

## G3 ELECTRIC CUT

Allows to use a grinder to cut slab tiles with the G3 guides.

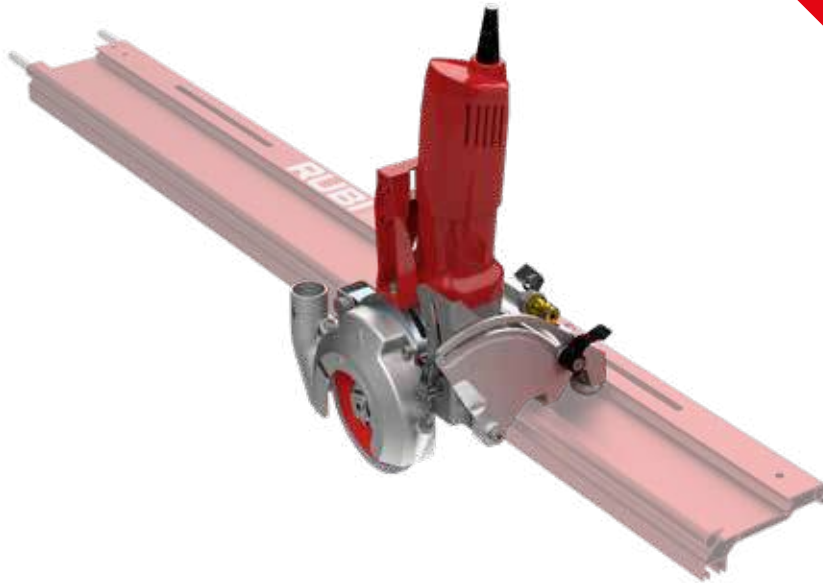

CATEGORY: SUPERPRO

CUT ANCHOR VENTILATED  
FAÇADE

DRY AND WET CUT

MITRE CUT (45°)

- **Angle grinder position regulation.** End-users can select and adjust their preferences.
- **Multiple positions.** Allows for straight cuts, mitre cuts (45°), and side cuts at 90° for slots for ventilated facade anchors. The regulation on ventilated facade allows us to adapt to different tile thicknesses.
- **Wet and dry cutting.** With water connection and dust extractor adapter, it enables both dry and wet cutting.
- **Guide adjustment regulation.** Improves the quality of the cut.
- Compatible with most angle grinders on the market.
- Compatible with Ø115 and 125 discs.
- Water inlet for the hose.
- Strap for the grinder accessory.
- Includes TVR-125 SUPERPRO diamond disc. The guide is not included.
- Maximum straight cut thickness (90°): Ø125 disc: 25 mm, Ø115 disc: 20 mm.
- Maximum mitre cut thickness (45°): Ø125 disc: 20 mm, Ø115 disc: 15 mm.

	REF.				
ANGLE GRINDER ACCESSORY G3	16929	3/4" 20 / 25 mm	4 1/2/4 7/8" 115 / 125 mm	5/8/ 20 mm* 15 / 20 mm	1
ANGLE GRINDER ACCESSORY G3 USA	52959				

\*The pictures of this product might be slightly different to its final version.

## SLAB CUTTING ACCESSORIES

2  
Cut & Drill

CATEGORY: PREMIUM

CUTTING HEIGHT 6-20 mm

POWER

## SLAB BREAKER PLUS

- Auxiliary breaker for the cut of slim porcelain slabs or large tiles.
- To separate thicknesses of 6 mm up to 20 mm.
- Soft-grip handle for a better comfort and ergonomic.
- With width adjustment system, to achieve an equal, uniform and symmetric distribution of breaking forces when cutting narrow strips.
- Rubber pressure pad for greater control and more precise separation.

	REF.			
SLAB BREAKER PLUS	18917	1/4/3/4" 6 / 20 mm	1	48

NEW!



CATEGORY: PRO

CUTTING HEIGHT

ERGONOMIC

## SLAB PLIERS

- For separating tiles up to 18 mm thick that have previously been scratched with a manual tile cutter.
- Specially designed for large format tiles and porcelain slabs.
- Two-in-one pliers and separator.
- \*The pictures of this product might be slightly different to its final version.

	REF.		
SLAB PLIERS	28916	3/4" 18 mm	1



**CATEGORY: SUPERPRO**



**SLIM CUTTER G2 HEAD**

- Tilting carriage with an ergonomic handle for the G2 cutting system.
- Improves the fixing on the guides.

	REF.	
SLIM CUTTER G2 HEAD	27911	1

**CATEGORY: SUPERPRO**



**SLIM CUTTER G2 SUPPLEMENT GUIDES**

- Aluminium guides for the G2 system.

	REF.	
SLIM CUTTER G2 SUPPLEMENT GUIDE 65 CM.	52948	1
SLIM CUTTER G2 SUPPLEMENT GUIDE 155 CM.	51999	

**CATEGORY: PREMIUM**

**EXTREME**



**22MM SCORING WHEEL PLUS EXTREME (Ø 7/8") TP/TQ/RCH/SLAB CUTTER**

- For sharp cuttings in hard ceramic and porcelain tiles.
- Tungsten Carbide scoring wheel with a superficial Titanium treatment.
- Mounted on bearing. Enhanced smooth user perception.
- Extra-long life.

	REF.		
22MM SCORING WHEEL PLUS EXTREME (Ø 7/8") TP/TQ/RCH/SLAB CUTTER	01901	5	-

**NEW!**



**CATEGORY: SUPERPRO**

**USE: OCCASIONAL**

**ACCESSORY FOR TC-125 G2 FREE CUT**

- Accessory for TC-125 G2.
- Allows TC-125 G2 do free and parallel cuts to the corner cuts. (without the need of guide).
- \*The pictures of this product might be slightly different to its final version.

	REF.				
ACCESSORY FOR TC-125 G2 FREE CUT	52828	4 1/2 / 4 7/8" 115 / 125 mm	5/8 / 7/8" 16 / 21 mm	3/8 / 1/2" 9 / 13 mm	1



## SLAB TRANS HEAVY DUTY N

**FULLY ADJUSTABLE FRAMEWORK FOR HANDLING LARGE FORMAT CERAMIC, PORCELAIN AND NATURAL STONE SLABS.**

Especially suited for handling thicker sheet tiles.



CATEGORY: PREMIUM



USE: INTENSIVE



HIGH LOAD CAPACITY



SECURITY



- Reinforced aluminium profile joined by a system of sliders. Greater structural strength.
- Includes 2 perpendicular aluminium guides, for greater stiffness.
- Equipped with four retractable and removable Soft-Grip handles to adapt to every situation during installation. Six light coloured vacuum suction cups that do not leave marks on the tile. Increased load capacity.
- Fast and easy to assemble and disassemble. Easy fix system.
- Black anodized finish.
- Maximum load capacity: 170 kg.
- Dimensions: 3800x1700x237 mm. (assembled and deployed).
- Maximum handling size: 360 x 160 cm.
- Unitary box with RUBI's flexography and full-colour label.





	REF.				
<b>SLAB TRANS HEAVY DUTY N</b>	18982	149 5/8x66 7/8x9 3/8" 380x170x23,7 cm	80.24744 lb 36,4 kg	1	-

Additional vacuum suction cups available can be attached to the system but it does not increase the maximum load capacity of 170 kg.

ACCESSORIES			
	<b>REF. 18979</b> Vacuum suction pad SLAB TRANS HEAVY DUTY N	<b>REF. 21955</b> supplementary vacuum suction cup for guide set	<b>REF. 18934</b> Slab Trolley





# SLIM EASY TRANS PLUS

FOR TRANSPORTING OF LARGE-FORMAT SHEET TILES.



**CATEGORY: SUPERPRO**

**USE: PROFESSIONAL**

**RELIABILITY**

**SECURITY**

**STURDINESS**

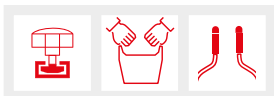

- Includes 2 retractable and adjustable guides of 170 to 320 cm of reinforced aluminium and six 20 cm suction cups (ref. 18827) with high load capacity. Provide added safety and reliability.
- The optimal recommended gripping distance is 700 mm (distance between handles).
- The soft-grip handles can slide and be removed through the top slot of the guides.
- Multiple position settings for the suction cups.
- Each guide is suitable for working individually, with a maximum load capacity of 40kg at their maximum length.
- Maximum load capacity: 80 kg.
- For workpieces with a maximum length of 3.2m.

	REF.					
<b>SLIM EASY TRANS PLUS</b>	18976	57.3196 lb 26 kg	61.7288 lb 28 kg	651 1/8x100 x89 3/4" 1654x254x228 cm	1	-

Adding more suction cups does not increase the load capacity.

ACCESSORIES		REF. 18819 supplementary guide set ERGO TILE TRANS / SLIM EASYTRANS PLUS		REF. 21955 supplementary vacuum suction cup for guide set		REF. 18979 Vacuum suction pad SLAB TRANS HEAVY DUTY N

# ERGO TILE TRANS

## BEST ADAPTABILITY FOR LIGHTER JOBS.

For the transport and handling of large formats of porcelain slabs.

**NEW!**



CATEGORY: SUPERPRO



LIGHT



SECURITY



RELIABILITY



- High workpiece clamping force. Due to its 6 suction cups Ø160, which can be moved along the guide, it provides an excellent grip on the workpiece.
- Easy folding and unfolding. Smooth and easy sliding of the slides thanks to their interlocking shape and the runners between them. Easy fixing and fastening by means of locking levers (without knobs).
- Comfortable and secure holding: Thanks to the highly reinforced steel handles with anti-slip grip, which allow a better grip of the whole. The handles can be folded to allow support on the support blocks in the laying position.
- Each guide can be used separately.
- Possibility of adjusting the tile in height, if the suction cup is slightly inclined, by means of manual levellers.
- Suction cups with safety indicator. Each suction cup, has an indicator that warns in the event of loss of suction.
- Easy release of the piece using the button on the suction cups or the tab on the suction cup rubber.
- The cups are protected to prevent damage during transport.
- Maximum load capacity: 80 kg.
- For workpieces with a maximum length of 3.2m.

	REF.					
<b>ERGO TILE TRANS</b>	28906	125 " 320 cm	36.3759 lb 16,5 kg	142 1/2x11 3/4x5 3/8" 362x30x13,6 cm	1	-

\*SUPPLEMENTARY CROSSBARS SLIM EASY TRANS/PLUS (ref. 18819). Increases the maximum load capacity to 120 kg.

\*\*The pictures of this product might be slightly different to its final version.

### ACCESSORIES



**REF. 18819** supplementary guide set ERGO TILE TRANS / SLIM EASY TRANS PLUS



**REF. 18934** Slab Trolley

# SLAB TRANS MINI

FOR TRANSPORTING CERAMIC SHEETS AND LARGE-FORMAT TILES WITH A MAXIMUM RECOMMENDED SIZE OF 60X60" (150 X 150 CM).



CATEGORY: SUPERPRO



USE: PROFESSIONAL



SECURITY



LIGHT

- **Ideal for medium formats. It adds less weight to the tile conveyor assembly when transporting medium-sized formats.**
- **Retractable aluminium guide. Allows us to handle and transport tiles 39 3/8" (100 cm) and 83" (210 cm) in size. Especially recommended for formats of up to 60x60" (150 x 150 cm), more than 5/16" (more than 8 mm) thick, used diagonally.**
- **Highly reinforced, adjustable and removable soft-grip handles. With an anti-twist and soft-grip system which ensures a better grip of the assembly.**
- **2 interchangeable Ø8" (20 cm) suction cups, can be placed at any point on the guide.**
- Suction cups with a safety indicator.
- Each suction cup, of Ø8" (20 cm) in diameter and with a high-load capacity, has an indicator that warns us in the event of a loss of suction.
- The suction cups have a protector to prevent damage during transport.
- With a maximum load capacity of 88 lb (40 kg) at their maximum length.
- Maximum load capacity: 121 lb (55 k g).

	REF.					
SLAB TRANS MINI	18983	18.29/818 lb 8,3 kg	24.69/152 lb 11,2 kg	90 x10 1/4x7 1/8" 231x26x18 cm	1	15

## ACCESSORIES



REF. 16909  
SLAB TRANS MINI  
SUPPORT FOR TABLE

# SLAB TROLLEY

**TRANSPORT AND HANDLING SYSTEM FOR LARGE-FORMAT SHEET TILES.**  
Especially suitable for handling thicker pieces.





**CATEGORY: PREMIUM**



**HIGH LOAD CAPACITY**

**EXCLUSIVE USE WITH  
SLAB/SLIM TRANS**



- Transport system and manoeuvre for large format tiles.
- Especially suitable for thicker/heavier slabs.
- Exclusive to the SLAB TRANS HD N (Ref.18982), ERGO TILE TRANS (ref: 28906) and SLIM EASY TRANS systems (Ref.18910+18819).
- Easy and quick to assemble and disassemble. Easy fix connection system.
- Ultra light and compact.
- Extendable support arm for greater ergonomics when loading and unloading pieces on the workbench.
- Maximum load capacity: 140 kg (including material and trans system).

	REF.				
<b>SLAB TROLLEY</b>	18934	46 1/8x29 3/8x6 1/2" 117x74,5x16,5 cm	39,6828 lb 18 kg	1	5





# RHINO TROLLEY

## TRANSPORT AND HANDLING SYSTEM FOR LARGE TILES.

Easy to transport due to its small size.



**CATEGORY: SUPERPRO**  
Category

**HIGH LOAD CAPACITY**

**VERSATILE**

- Very manageable and good stability thanks to its 2 swivel wheels (360°).
- It has a safety lock on the wheels to prevent undesirable movements.
- It can be transported on any type of surface, thanks to its large 125 mm diameter wheels.
- Ultralight and compact.
- 40 cm wide platform. It can transport several tiles at the same time of up to 40 mm thickness.
- Maximum load capacity: 250 kg.
- Maximum transport dimensions: 3000 x 1200 mm
- Rubber cover to protect the tiles.
- Compatible with the transporters.

	REF.				
<b>RHINO TROLLEY</b>	28912	35 3/8x17 1/8x10 " 90x43,4x27,8 cm	277796 lb 12,6 kg	1	-





# SLAB TABLE

**WORK BENCH FOR CUTTING AND HANDLING LARGE-FORMAT SHEET TILES USING THE SLAB SYSTEM RANGE OF TOOLS.**



**CATEGORY: SUPERPRO**

...  
**USE: INTENSIVE**

**STABILITY**

- Workbench to support the cutting and preparation of large format materials using the tools of the Slab system range.
- Extra-reinforced bars thus increasing the rigidity of the workbench.
- The structure of the table together with the levelling feet achieves a greater stability of the set.
- Assembly and disassembly fast and easy. Easy fix connection system (hammerhead screws).
- Folding legs. Equipped with security system against involuntary closing.
- Dimensions in working position: 1800x1044x700 mm.
- Dimensions in transport position: 1800x1044x198 mm.
- Working height: 70 cm.
- Maximum load capacity: 250 kg.

	REF.					
<b>SLAB TABLE</b>	18935	70 7/8x41 1/8x27 1/2" 180x104,4x70 cm	73.41318 lb 33.3 kg	79.3656 lb 36 kg	1	16

**ACCESSORIES**

**REF. 21931**  
SLAB TABLE LENGTHEN  
ACCESSORY

**REF. 21975**  
SLAB TABLE TILE LIFTING  
ACCESSORY (C-15)



# SLAB TABLE VERSA-TILE

**WORK BENCH FOR CUTTING AND HANDLING LARGE-FORMAT CERAMIC SHEETS, SPECIFICALLY DESIGNED FOR THE SLAB RANGE OF TOOLS.**

Work bench for cutting and handling large-format ceramic sheets, specifically designed for the SLAB range of tools.



**CATEGORY: PREMIUM**

**USE: INTENSIVE**

**STABILITY**

**VERSATILITY**

- Thanks to the shape of the legs and its structure, the table is very stable and sturdy even in its widest position. The adjustable feet ensure this stability, even on uneven floors.
- Dimensions in working position: The table is extendable from 1100 to 1515 mm, which allows you to handle the widest formats. Its length is 1800 mm.
- Its folding legs and two side wheels make it easy to transport and store.
- Double working height: 70 and 84 cm, which means it can be adapted to different needs, allowing all types of work to be carried out.
- Maximum load capacity: 260 kg. Even the largest tiles can be loaded.
- Thanks to its two movable bars and wide T-shaped profiles, you can have a support surface that allows you to work as if on a workbench for the use of smaller tools, such as hand-held cutters, for example.

	REF.					
<b>SLAB TABLE VERSA-TILE</b>	18984	70 7/8x60 1/4x33 1/8" 180x153x84 cm	90.3886 lb 41 kg	98.32516 lb 44.6 kg	1	9

**ACCESSORIES**



**REF. 21931**  
SLAB TABLE LENGTHEN  
ACCESSORY



**REF. 21975**  
SLAB TABLE TILE LIFTING  
ACCESSORY (C-15)



# RETRACTABLE WORKTABLE

**THE RETRACTABLE WORKBENCH PROVIDES A SUITABLE SUPPORT FOR ALL TYPES OF WORK.**  
The larger size is particularly suitable for cutting and handling large tiles.

**NEW!**

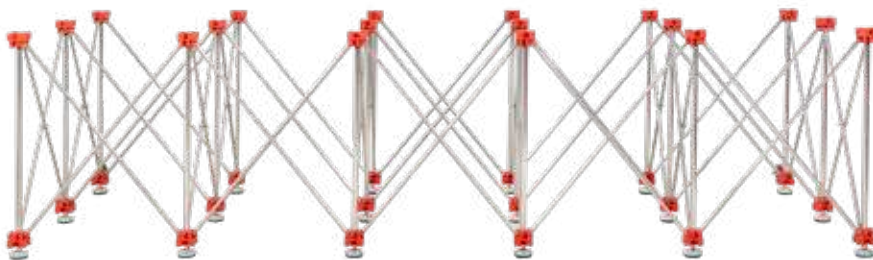

CATEGORY: PRO

USE: PROFESSIONAL

TRANSPORTABLE



- **Resistant.** Thanks to its structure with many support points, it allows very high loads.
- **Easy to store.** Once folded, it has a reduced size and is easy to store.
- **Easy to transport.** It has a storage bag and thanks to its two wheels it can be easily transported from one place to another.
- **Easy to assemble and disassemble.** By simply pulling on the ends, we get a wide support for all our work. The addition of crossbars also provides greater stability and safety.
- Lightweight retractable structure with high load capacity.
- Easy to transport with wheels and carrying bag.
- Takes up very little space when folded.
- Easy to assemble and disassemble almost instantly, no tools required.
- Deployed dimensions.
- 300 X 120 TABLE: 75 x 300 x 120 cm.
- 120 X 120 TABLE: 75 x 120 x 120 cm.
- Maximum load (depending on final material):
- 300 X 120 TABLE: 1500 kg.
- 120 X 120 TABLE: 700 kg.

	REF.	
RETRACTABLE WORKTABLE 120X120	28918	1
RETRACTABLE WORKTABLE 300X120	28917	

\*The pictures of this product might be slightly different to its final version.

## SLAB HANDLING ACCESSORIES

3  
Set

## CATEGORY: SUPERPRO

## SUPPLEMENTARY GUIDE SET ERGO TILE TRANS / SLIM EASY TRANS PLUS



- ERGO TILE TRANS and SLIM EASY TRANS PLUS has a set of perpendicular guides for increased stability.
- With the supplementary guide set we increase the maximum load capacity to 120kg.
- Increases the rigidity of the unit.
- Facilitates handling of the pieces.
- Fast and easy to assemble and disassemble.
- Black anodized finish.

	REF.	
SUPPLEMENTARY GUIDE SET ERGO TILE TRANS / SLIM EASY TRANS PLUS	18819	1

## CATEGORY: PREMIUM

## VACUUM SUCTION PAD SLAB TRANS HEAVY DUTY N



- The suction cup addition is an accessory compatible only with SLAB TRANS HEAVY DUTY N (Ref. 18982), SLIM EASY TRANS PLUS (Ref.18976) and SLAB TRANS MINI (Ref. 18983). The suction cup can be fixed to any type of surface without leaving a mark on the part. Its use allows the suction cups to be replaced while maintaining the original maximum load capacity of the transporter at all times.

	REF.		
VACUUM SUCTION PAD SLAB TRANS HEAVY DUTY N	18979	1	1

NEW!

## CATEGORY: SUPERPRO

## SUPPLEMENTARY SUCTION CUP FOR ERGO TILE TRANS



- Diameter of the suction cup: Ø160 mm
- Support bracket made in Steel.
- Includes protector for the rubber of the suction cup.
- Not compatible with the rest of transporters of the SLAB SYSTEM family.
- \*The pictures of this product might be slightly different to its final version.

	REF.		
SUPPLEMENTARY SUCTION CUP FOR ERGO TILE TRANS	28910	6 1/4" 160 mm	1

## CATEGORY: PREMIUM

## SUPPLEMENTARY VACUUM SUCTION CUP FOR GUIDE SET



- Additional suction cup to place on the crossbars in the SLAB TRANS HEAVY DUTY N (Ref.18982) and SLIM EASY TRANS PLUS (Ref.18976) + CROSSBARS SET (Ref.18819).
- Provides rigidity in the transport of very thin workpieces.
- Facilitates the transport of cut workpieces.

	REF.	
SUPPLEMENTARY VACUUM SUCTION CUP FOR GUIDE SET	21955	1



**CATEGORY: SUPERPRO**

**SLAB TRANS MINI SUPPORT FOR TABLE**

- Solely for use with the SLAB TRANS MINI and the SLAB TABLE.
- Helps to place the workpiece on the SLAB TABLE & VERSA-TILE in the back buttering position without having to remove the conveyor.

	REF.		
SLAB TRANS MINI SUPPORT FOR TABLE	16909	1	81



**CATEGORY: PREMIUM**

**SLAB TABLE LENGTHEN ACCESSORY**

- Accessory for the SLAB VERSA-TILE TABLE (Ref 18984), it allows you to extend the table up to 3 m while maintaining its basic features.
- Also compatible with the SLAB TABLE.

	REF.		
SLAB TABLE LENGTHEN ACCESSORY	21931	1	6



**CATEGORY: PREMIUM**

**SLAB TABLE TILE LIFTING ACCESSORY (C-15)**

- Makes it possible to lift the workpiece 4.5 cm from the SLAB TABLE/SLAB VERSA-TILE TABLE profiles (only "T" profiles).
- Ideal for all types of cross-cutting and drilling on the table without the risk of damaging the profiles.

	REF.	
SLAB TABLE TILE LIFTING ACCESSORY (C-15)	21975	1





# RUBI TRILLER

## COMPACT MANUAL VIBRATOR.

Especially designed for vibrating large format tiles.



CATEGORY: SUPERPRO

USE: INTENSIVE

EFFICIENCY



- Compact manual vibrator especially designed for vibrating large format tiles.
- Expels the air trapped under the tile and maximises the adhesive coverage.(Do not use for a long period of time on the same tile to prevent the adhesive escaping.)
- Suitable for use on floor and wall tiles.
- Compact and light design weighing just 4.8 kg to facilitate work on walls.
- Floating carbon steel chassis with vibration reduction system for greater user comfort.
- Vibration plate made of PUR plastic, non-marking and easy to change.
- Easy to change, non-marking contact plate.
- Easy to operate tool with ergonomic double grip.
- Non-adjustable vibration frequency.

	REF.		RPM			
RUBI TRILLER	18948	220-230v 50/60Hz	2940	11 1/2x9 1/2x7 1/4" 29,2x24,2x18,5 cm	10.58208 lb 4,8 kg	1
RUBI TRILLER USA	18978	110-130v 50/60Hz				

# RUBI TRILLER ENERGY CAS

## COMPACT MANUAL BATTERY-POWERED VIBRATOR.

Especially designed for vibrating large-format ceramic sheets.



### COMPATIBILITY

RUBIMIX E-9 ENERGY CAS	18 V 5.2 Ah
RUBIMIX E-10 ENERGY CAS	18 V 5.2 Ah
ANGLE GRINDER TECH	18 V 5.2 Ah
RUBI LUMEO	18 V 5.2 Ah
QUAKE ENERGY CAS	18 V 2.0 Ah
RUBI TRILLER ENERGY CAS	12 V 4.0 Ah







  
CATEGORY: PREMIUM

...  
USE: INTENSIVE

EFFICIENCY

  
CAS BATTERY COMPATIBLE

- Expels the air trapped under the tile and maximises its wetting. (Do not use for a long period of time on the same tile to prevent the adhesive escaping.)
- Suitable for use on floor and wall tiling (suitable for vertical and horizontal application, floors and walls).
- Compact and light design weighing just 5.8 kg to facilitate work on vertical surfaces.
- Floating carbon steel chassis with vibration reduction system for greater user comfort.
- Folded 1.5 mm steel sheet chassis, powder painted in red.
- Vibration plate made of PUR plastic, non-marking and easy to change.
- Easy to operate tool with ergonomic double grip.
- It has a speed regulator to adapt the vibration to the material and substrate being worked on. It includes a circuit breaker safety system.
- Powered by a Li-HD 12V 4Ah battery (compatible with 12 V batteries from the Metabo CAS platform).
- Includes Rubi BMS (Battery Management System), this is a quality electronic controller that protects the battery system from any overloads and overheating. Furthermore, it optimises the performance of the battery by offering a regular energy flow and extends the autonomy of use as well as the battery life.

	REF.		RPM			
<b>RUBI TRILLER ENERGY CAS EU</b>	10971	12V 4Ah	3000	9 1/2x11 1/2x7 1/8" 24,2x29,2x17,9 cm	12.78668 lb 5,8 kg	1
<b>RUBI TRILLER ENERGY CAS UK</b>	10972					
<b>RUBI TRILLER ENERGY CAS USA</b>	10973					
<b>RUBI TRILLER ENERGY CAS</b>	10913					
<b>BATTERY CAS LIHD 12V 4AH</b>	85904	12V 2Ah				
<b>BATTERY CAS LIPOWER 12V 2AH</b>	85903					



# QUAKE ENERGY CAS

## LIGHT AND COMPACT VIBRATOR

For tiles or porcelain sheets.



  
CATEGORY: PREMIUM

...  
USE: INTENSIVE

  
LIGHT



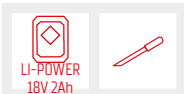

  
CAS BATTERY COMPATIBLE

### COMPATIBILITY

RUBIMIX E-9 ENERGY CAS	18 V 5.2 Ah
RUBIMIX E-10 ENERGY CAS	18 V 5.2 Ah
ANGLE GRINDER TECH	18 V 5.2 Ah
RUBI LUMED	18 V 5.2 Ah
QUAKE ENERGY CAS	18 V 2.0 Ah
RUBI TRILLER ENERGY CAS	12 V 4.0 Ah



- Designed to prevent the generation of encapsulated air bubbles between the adhesive and the back of the ceramic tile, thus facilitating ideal adhesion between the adhesive and the tile.
- The low weight and wireless system make it easy to use on vertical supports and work at height.
- The double handle with bi-material handle offers greater ergonomics and comfort to the user, and its geometry facilitates better control and stability of the tool during vibrating.
- The contact base with the ceramic tile does not leave marks and is easily replaceable.
- The front handle improves ergonomics and gives the user a better experience.
- Powered by CAS Li-Power 18V 2Ah battery, compatible with Metabo brand battery tools and with all those that are part of the CAS 18V platform.
- It has a progressive on-off switch (rpm control).
- LED battery-charge indicator.
- New CAS platform LI-POWER 18V-2 Ah battery.

	REF.		RPM				
QUAKE ENERGY CAS EU	60934	18V 2Ah	10000 Max	5 1/8" 127 mm	3.3069 lb 3.1 kg	4.4092 lb 4.05 kg	2
QUAKE ENERGY CAS UK	60942						
QUAKE ENERGY CAS USA	60938						
QUAKE ENERGY CAS WITHOUT BATTERY	60953				7.0040142 lb 2.69 kg	14.010233 lb 3.18 kg	
BATTERY CAS LIPOWER 18V 2AH	85901						

# OCTO-USB ENERGY

## SAFE & EASY TO USE

Suction cup to lift ceramic tiles with smooth or slightly textured and clean surfaces.



NEW!

CATEGORY: PRO

USE: PROFESSIONAL

SECURITY  
140 kg

USB BATTERY



- Battery suction cup designed for handling ceramic tiles.
- 3.7V / 2 Ah. battery integrated in the suction cup and charging via USB-C cable. (cable included, charger not included).
- Water and dust proof buttons. IP30.
- Digital display with 4 indicators: Vacuum / Release / ON / Charge + MBAR pressure info screen.
- Max load capacity: 140 kg only for flat & smooth surfaces and horizontal handling.
- Plastic case for transport and protection.

	REF.					
<b>OCTO-USB ENERGY</b>	66967	3.7V / 2Ah	8 5/8" 220 mm	2.667566 lb 1.21 kg	3.3069 lb 1.5 kg	10



## INSTALLATION

3  
Set

NEW!



CATEGORY: SUPERPRO

MULTIANGLE

## ANGLE TILE REGULATOR

- The angle tile gap regulator is designed for corner adjustment during the installation, especially for large formats which are more difficult to manipulate.
- It allows 90°, 180° and 270° alignment and tile gap adjustment at the same time. Very useful for countertops installation.
- Comfortable and accurate adjustment.
- Easy deactivation of the suction cups by means of the tab at the base of the suction cups.
- Metal gearing for longer life
- Recommended to use in pair.
- \*The pictures of this product might be slightly different to its final version.

	REF.		
ANGLE TILE REGULATOR	03995	5 7/8" 150 mm	1





NEW!



CATEGORY: PRO

## TILE GAP CLOSER

- For a precise and easy adjustment of the gap between tiles during floor or wall tiling.
- Large diameter suction cups (150 mm) for any kind of tile surface (flat, rough, structured, etc.)
- For lateral displacement of tiles and gap reduction between 0 - 40 mm.
- Enables to equal the level of the tiles between 0 - 20 mm.
- Maximum lifting capacity up to 100 Kg (220 lbs).

	REF.					
TILE GAP CLOSER	60926	5 7/8" 150 mm	18 7/8X5 7/8X4 3/4" 48X15X12 cm	7.958606 lb 3,61 kg	8.465664 lb 3,84 kg	1





CATEGORY: PREMIUM

VACUUM

 SECURITY 110 kg

## SC-200 SUCTION CUP WITH VACUUM PUMP

- Suction cup for handling large and heavy tiles.
- Special for textured surfaces.
- Adapts to any surface finish.
- Suction applied by manual vacuum pump.
- Load loss indicator (red mark).
- Pressure-release mechanism.
- Maximum load capacity: 243 lb (110 kg).

	REF.				
SC-200 VACUUM PUMP CUP	18919	7 7/8" 200 mm	33069 lb 1,6 kg	8	90





**CATEGORY: PREMIUM**

**VACUUM**

**SECURITY 110 kg**

**NO MARKS**

### GSC-200 VACUUM SUCTION CUP

- Suction cup for the manipulation of large ceramic tiles and heavy porcelain slabs.
- Adapts to the surface without leaving any marks.
- Fixing by vacuum manual pump.
- Load loss indicator (red mark).
- Pressure release mechanism.
- Maximum load capacity: 110 kg.
- High resistance plastic body.
- Transport suitcase.

	REF.				
<b>GSC-200 GREY VACUUM SUCTION</b>	21951	7 7/8" 200 mm	3.3069 lb 1.5 kg	8	90





**NEW!**

**CATEGORY: PREMIUM**

**ERGONOMIC**

### ERGO TILE BEATER

- For a good settlement of tiles.
- It facilitates the extraction of the air that remains between the tile and the adhesive.
- With a bi-material handle for maximum comfort and ergonomics.
- Metal plate for complete rigidity and long durability, reinforced with rubber to avoid damaging the ceramic tiles.

	REF.		
<b>ERGO TILE BEATER 1,4 KG</b>	28900	3.08644 lb 1,4 kg	3
<b>ERGO TILE BEATER 3,2 KG</b>	28931	7.05472 lb 3,2 kg	



**CATEGORY: SUPERPRO**

### TILE BEATING BLOCK

- For a good settlement of tiles.
- Waterproof and high wear resistance wood.
- Perfect flatness.
- Dimensions: 15 3/4" x 5 3/4" (40x14,5 cm.)
- Ref. 72980 with white natural rubber sheet to prevent damage to the tile.

	REF.	
<b>TILE BEATING BLOCK 40 X 14,5 CM. WITH RUBBER</b>	72980	1



# ELECTRIC

## TILE CUTTING





---

Electric cutters  
Circular saw and vacuum cleaner



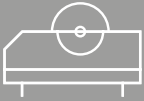

# SELECTION TABLE

						 with plunge effect
		cm	inch	mm	inch	
●●● Intensive	DX-N	148	58 7/16"	300-350	12-14"	○
	DR	84	33"			
	DS-N	152	59 13/16"	250	10"	○
	DCX-XPERT	155	61"			
●●● Professional	DC-SMART ADVANCE	121	48"	125	5"	-
	DC-PYTHON	121	48"			
	DT	90	59 1/2"			
	DWD	125	49 3/16"			
	DL	124	48 13/16"			
	DV	106	41 3/4"			
●●● Occasional	DU-EVO	85	33"	200	8"	-
	ND	∞				



			W											
<b>PREMIUM</b>	Intensive	DX-350 N 1000	3 CV/HP	2,2 KW	(*4) 118,5 cm 46 5/8"	(*4) 83,5 X 83,5 cm 32 7/8 X 32 7/8"	∞	(*5) 65 mm 2 9/16"	105 / 220 mm 4 1/8" / 8 11/16"	300 - 350 mm 12 - 14"	92 Kg. 203 Lb.	○	○	
		DX-350 N 1300	3 CV/HP	2,2 KW	(*4) 148,5 cm 58 7/16"	(*4) 105 X 105 cm 41 5/16 X 41 5/16"	∞	(*5) 65 mm 2 9/16"	105 / 220 mm 4 1/8" / 8 11/16"	300 - 350 mm 12 - 14"	100 Kg. 220 Lb.	○	○	
		DS-250 N 1000	3 CV/HP	2,2 KW	102 cm 40 3/16"	72 X 72 cm 28 3/8 X 28 3/8"	∞	(*3) 25 mm 1"	51 mm 2 1/16"	250 mm 10"	91,5 Kg. 201.7 Lb.		○	
		DS-250 N 1300	3 CV/HP	2,2 KW	132 cm 51 15/16"	93,5 X 93,5 cm 36 13/16 X 36 13/16"	∞	(*3) 25 mm 1"	51 mm 2 1/16"	250 mm 10"	96,5 Kg. 212.7 Lb.		○	
		DS-250 N 1500	3 CV/HP	2,2 KW	152 cm 59 13/16"	107,5 X 107,5 cm 42 5/16 X 42 5/16"	∞	(*3) 25 mm 1"	51 mm 2 1/16"	250 mm 10"	100 Kg. 220 Lb.		○	
		DCX-250 XPERT 1250	2 CV/HP	1,5 KW	125 cm 49 3/16"	90 X 90 cm 35 7/16 X 35 7/16"	∞	50 mm 1 15/16"	61 / 90 mm 2 3/8" / 3 9/16"	250 mm 10"	83 Kg. 183 Lb.	○	○	○
		DCX-250 XPERT 1550	2 CV/HP	1,5 KW	155 cm 61"	110 X 110 cm 43 5/16 X 43 5/16"	∞	50 mm 1 15/16"	61 / 90 mm 2 3/8" / 3 9/16"	250 mm 10"	- -	○	○	○
<b>SUPERPRO</b>	Professional	DR-350	3 CV/HP	2,2 KW	(*4) 84 cm 33"	(*4) 43,5X43,5 cm 17 X 17"	∞	(*5) 71 mm 2 13/16"	95 / 150 mm 3 3/4" / 5 7/8"	300 - 350 mm 12 - 14"	63 Kg. 139 Lb.	○	○	
		DC-SMART ADVANCE 1200	1,5 CV/HP	1,1 KW	(*2) 121 cm 47 5/8"	(*2) 85 X 85 cm 33 7/16 X 33 7/16"	∞	55 mm 2 3/16"	61 / 90 mm 2 3/8" / 3 9/16"	250 mm 10"		○	○	
		DC-250 PYTHON 850	1,5 CV/HP	1,1 KW	(*2) 98 cm 38 9/16"	(*2) 69,5 X 69,5 cm 27 3/8 X 27 3/8"	∞	50 mm 1 15/16"	61 / 90 mm 2 3/8" / 3 9/16"	250 mm 10"	54,5 Kg. 120 Lb.	○	○	
		DC-250 PYTHON 1200	1,5 CV/HP	1,1 KW	(*2) 120,5 cm 48"	(*2) 85 X 85 cm 33 7/16 X 33 7/16"	∞	50 mm 1 15/16"	61 / 90 mm 2 3/8" / 3 9/16"	250 mm 10"	59,5 Kg. 131 Lb.	○	○	
		DT-250 MAX	2,4 CV/HP	1,8 KW	90 cm 36"	60 X 60 cm 24 X 24"	∞	25 mm 1"	90 mm 3 9/16"	250 mm 10"	45 kg. 99 Lb.	○	○	○
		DWD-125 DUO CUT 1250	1,5 CV/HP	1,1 KW	90 cm 36"	88 X 88 cm 34 5/8 X 34 5/8"	∞		30 mm 1 13/16"	125 mm 4 1/16"	40 kg. 88 Lb.	○	○	○
		DL-125 1200	2,3 CV/HP	1,8 KW	125 cm 49 3/16"	90x90 cm 35 7/16" X 35 7/16"	∞	20 mm 13/16"	20 mm 13/16"	125 mm 4 1/16"	50 Kg. 110.23 Lb.	○	○	○
DV-200 1000	1,5 CV/HP	1,1 KW	106 cm 41 3/4"	76,5 X 76,5 cm 30 1/8 X 30 1/8"	∞	(*3) 15 mm 9/16"	35 mm 1 3/8"	200 mm 8"	57,5 Kg. 126.8 Lb.		○			
<b>PRO</b>	Occasional	DU-200 EVO 650	1,1 CV/HP	0,8 KW	65 cm 26"	45 X 45 cm 18 X 18"	∞	20 mm 13/16"	35 mm 1 3/8"	200 mm 8"	22,5 Kg. 49.6 Lb.		○	○
		DU-200 EVO 850	1,1 CV/HP	0,8 KW	85 cm 33"	60 X 60 cm 24 X 24"	∞	20 mm 13/16"	35 mm 1 3/8"	200 mm 8"	27,2 Kg. 60 Lb.		○	○
		ND-200	1,1 CV/HP	0,8 KW	∞	∞	(*1) 23 cm 9"	24 mm 15/16"	40 mm 1 9/16"	200 mm 8"	17,2 Kg. 37.9 Lb.			
		ND-180	0,7 CV/HP	0,55 KW	∞	∞	20 cm 8"	22 mm 7/8"	35 mm 1 3/8"	180 mm 7"	13,6 Kg. 29 Lb.			

(\*1) With lateral stop.

(\*2) 13/32" (10mm) thick material and plunge effect.

(\*3) With special decks for mitring.

(\*4) With Ø12" (300mm) blade, 13/32" (10mm) thick material and plunge effect.

(\*5) With Ø14" (350mm) blade.

(\*6) Saw head in the lowest position

## DX-350 N

### MOBILE HEAD MACHINE WITH PLUNGE EFFECT FOR TOTAL VERSATILITY.

For all types of ceramic and porcelain tiles, building materials such as marble, granite, facade and fireproof bricks.



CATEGORY: PREMIUM



USE: INTENSIVE



POWER

3

3 cv/hp

VERSATILITY



- **Motor assembly mounted on sliding bearings for maximum precision and reliability. Perfect finishes.**
- **Folding legs with integrated castors: Pyramidal orientation to improve the stability and safety of the machine.**
- **Aluminium structure. Lighter cutter with maximum resistance to working conditions.**
- **High performance plunge effect. Maximum cutting height.**
- Equipped with protective safety system for segmented blades.
- With thermal security switch.
- Water pump cooling of blade with flow control valve.
- Diamond blade Ø 14" (350 mm) not included.
- Allows the use of a Ø 12" (300 mm) blade.
- Adjustable mobile head with plunge effect capability.
- Motor on top and belt transmission.
- With lateral stop for repetitive cuts.
- Aluminium working surface removable for easy cleaning.
- Removable water tank system.
- 2mW line laser.
- Circular level for easy field installation.
- Machine supplied without cable.
- Supplied with ZERO DUST system already assembled. Also provided with a second anti-splash standard protector



REF.	⚡	RPM	⊠	✂️	⬠	⚙️	⚙️	⚙️	⚙️	⚙️	⚙️	⚙️	⚙️	⚙️	⚙️	⚙️	
<b>DX-350-N 1000</b>	52905	230V-50 Hz	2800	40 3/8" 102,5 cm	46 5/8" 118,5 cm	32 7/8x32 7/8" 83,5x83,5 cm	∞"	∞ cm					66 7/8x33 7/8x56 1/4" 170x86x143 cm	202.8252 lb 92 kg			
	52906	220V-60 Hz	3400														
<b>DX-350 N 1300</b>	52915	230V-50 Hz	2800	52 1/8" 132,5 cm	58 1/2" 148,5 cm	41 3/8x41 3/8" 105x105 cm	2 1/2" 65 mm	4 1/8/8 5/8" 105 / 220 mm	1 1/8" 25,4 mm	11 3/4-13 3/4" 300-350 mm	78 3/4x33 7/8x56 1/4" 200x86x143 cm	220.46 lb 100 kg	√	1	**1		
	52916	230V-60 Hz	3400														
	52918	120V-60 Hz 1Inch.															
	52927	230V-50 Hz 2,4HP	2830														
	52928	110V-50 Hz	2700														

Cutting capabilities may vary depending on the head position, special plates and disc diameter.  
Ref. 52927 and 52928: 2.4 CV/HP.

<b>ACCESSORIES</b>		<b>REF. 51916</b> Tile Fixer DV/DC/DCV/DS/OX		<b>REF. 51915</b> Set of flanges Ø184mm DX-350		Cables with plug

## DS-250 N

**MOBILE HEAD MACHINE FOR HIGH ACCURACY.**

For wall tiles, floor tiles, porcelain tiles, marble, granite and other materials.



CATEGORY: PREMIUM



USE: INTENSIVE



POWER  
3 cv/hp



MITRE CUT (45°)



- **Motor assembly mounted on sliding bearings for maximum precision and reliability. Perfect finishes.**
- **Folding legs with integrated castors: Pyramidal orientation to improve the stability and safety of the machine.**
- **Wheels and handle included. Easy transport.**
- **Aluminium structure. Lighter cutter with maximum resistance to working conditions.**
- Removable aluminium tables for easy cleaning of the machine.
- With thermic security switch.
- Water pump cooling of blade with flow control valve.
- Diamond blade Ø10" (250mm) not included.
- With a double set of flanges, one especially designed for mitre cuts.
- Motor assembly mounted on sliding bearings for mitre cuts.
- Safety protector for segmented blades.
- With lateral stop for repetitive cuts.
- Removable water tank system.
- 2mW line laser.
- Spirit level for easy field installation.
- Machine supplied without cable.
- Supplied with ZERO DUST system already assembled. Also provided with a second anti-splash standard protector





REF.	⚡	RPM	↔	⬠	⬢	⬡	⬢	⊕	⊖	⊞	⊞	⊞	⊞	
<b>DS-250 N 1000</b>	52920	230V-50 Hz.	2800	40 1/8"	28 3/8x28 3/8"	2 1/8"	"	1 1/8"	9 7/8"	66 7/8x33 7/8x50"	201.7209 lb	242.506 lb	1	**1
				102 cm	72x72 cm							170x86x127 cm		
<b>DS-250 N 1300</b>	52930	220V-60 Hz.	3400	51"	36 3/4x36 3/4"	51 mm	25 mm	25,4 mm	250 mm	78 3/4x33 7/8x50"	212.7439 lb	264.552 lb	1	**1
				132 cm	93,5x93,5 cm							200x86x127 cm		
<b>DS-250 N 1500</b>	52940	220V-60 Hz.	3400	59 7/8"	42 3/8x42 3/8"	107,5x107,5 cm				86 5/8x33 7/8x50"	220.46 lb	275.575 lb	1	**1
	52942			152 cm	107,5x107,5 cm							220x86x127 cm		

Cutting capabilities may vary depending on the head position, special plates and disc diameter.  
 Ref. 52945 (3F): 4 CV/HP.

<b>ACCESSORIES</b>		<b>REF. 51916</b> Tile Fixer DV/DC/DCX/DS/DX		<b>REF. 51914</b> Roller Table Extension DU/DC/DCX/DS/DX (from 2013)		Cables with plug
--------------------	--	---	--	--	--	------------------



## DCX-250 XPERT

**PROFESSIONAL MOVING HEAD MACHINE FOR WET CUTTING WITH PLUNGE EFFECT.**  
For occasional cutting of natural stone such as marble or granite.



CATEGORY: PREMIUM



USE: INTENSIVE



RELIABILITY



PRECISION



PATENTED



- **Reinforced aluminium chassis with innovative triple beam system and steel sides. Improves the stability and rigidity of the chassis.**
- **Reinforced cutting guide for a better cut finish.**
- **C3-PYTHON System increases cooling efficiency and reduces water dispersion.**
- **High performance plunge effect. Cutting height adjustment.**
- Includes transport handle and off-road type reinforced wheels, which provide better transportability and handling of the machine.
- Steel double settling system for improved efficiency and water recovery.
- Angular measurement with aluminium square adjustable from 0° to 60° for repetitive cuts.
- Includes reinforced folding legs with folding-prevention system and quick lock.
- External and easy to remove water tank with 30 L capacity.
- Includes improved splash guard system with auto-sliding protective cover.
- Patented ZERO DUST system exclusive to RUBI certified by the TNO, for safe exposure thanks to the reduction of the breathable dust particles generated during the cut.
- Ergonomic bi-material handle for comfortable operation of the cutting head.
- Earth integrated into the chassis.
- Does not include power cable.
- Not Supplied with a blade.



REF.	⚡	RPM	→	↺	⬠	⬢	⬢	⬢	⬢	⬢	⬢	⬢	⬢	⬢	⬢
<b>DCX-250 XPert 1250</b>	52960	230V-50Hz	2750	49 1/4" 125 cm	52 3/8" 133 cm	35 3/8x35 3/8" 90x90 cm	2 3/8/3 1/2" 60 / 90 mm	1" 50 mm	1 1/8" 25,4 mm	9 7/8" 250 mm	171.9588 lb 78 kg	75 5/8x29 1/8x51 1/8" 192x74x130 cm	1	**1	273.3704 lb 124 kg
	52961	110V-50Hz													
	52929	220V-60Hz	3350												
	52962	120V-60Hz													
<b>DCX-250 XPert 1550</b>	52970	230V-50Hz	2750	61 1/8" 155 cm	64 1/8" 163 cm	43 1/4x43 1/4" 110x110 cm	2 3/8/3 1/2" 60 / 90 mm	1" 50 mm	1 1/8" 25,4 mm	9 7/8" 250 mm	189.5956 lb 86 kg	87 3/8x29 1/8x51 1/8" 222x74x130 cm	1	**1	273.3704 lb 124 kg
	52971	110V-50Hz													
	52937	220V-60Hz	3350												
	52972	120V-60Hz													

The cutting capacities can vary depending on the head position, special flanges and disc diameter.

ACCESSORIES				
	<b>REF. 51927</b> Set of flanges Ø170mm DC PYTHON/DCX		<b>REF. 57941</b> Table Extension DV/DC/ DCX/DS/DX	 Cables with plug



**NEW**  
**DC-250**  
**SMART ADVANCE**

—  
True Intelligent Cutting.

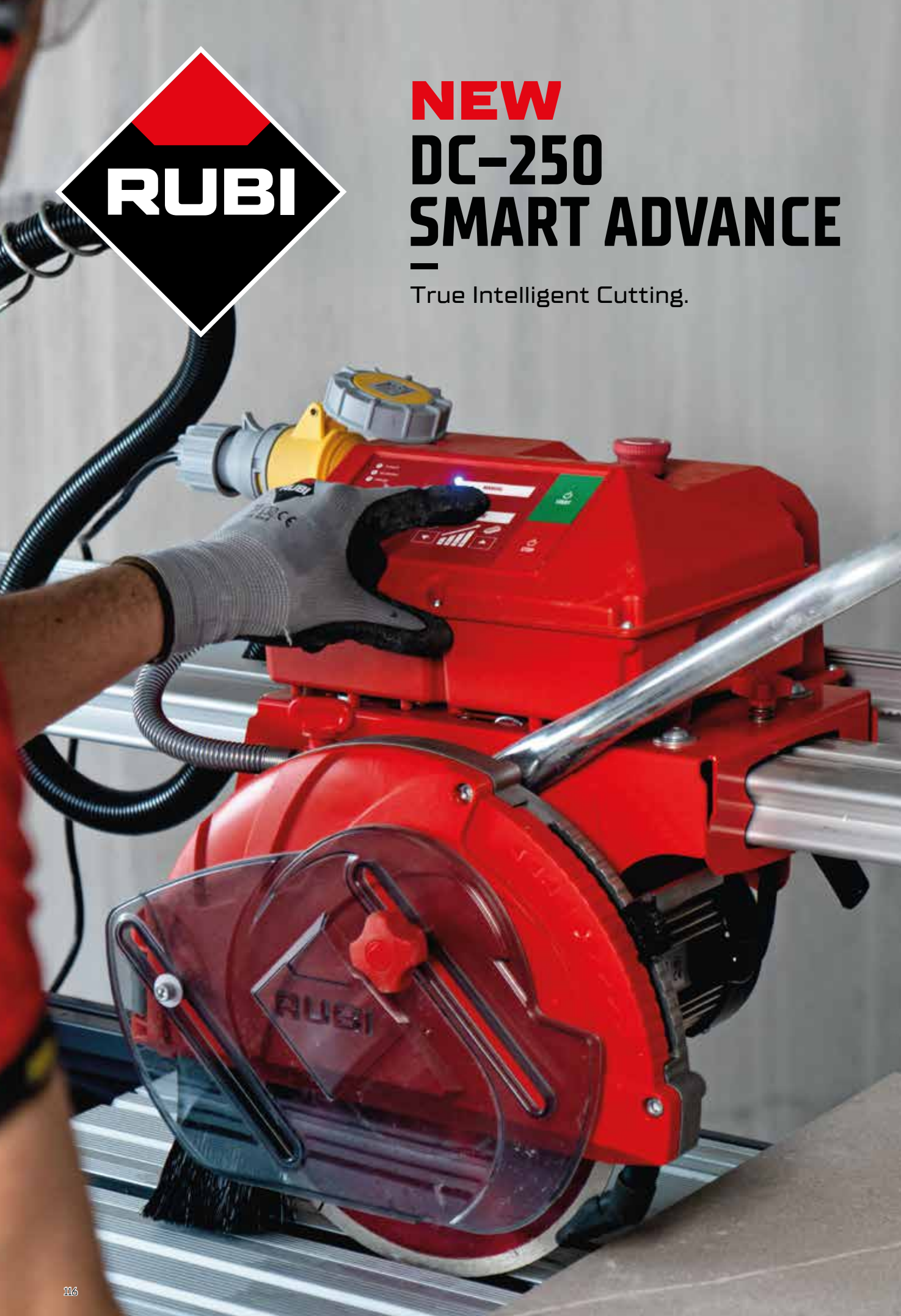

# THE TILE CUTTER THAT ADAPTS, PERFORMS AND PROTECTS.

Imagine a day in the life of a professional. Hours spent ensuring that every cut is precise, every edge smooth and every part perfectly adjusted. The job is demanding. Manual control is unpredictable, inconsistent and requires constant adjustments to suit materials and blade conditions. The **DC-250 SMART ADVANCE**, a tool designed to redefine how you cut. It's not just a cutter: it's your partner in precision.

When preparing tiles, the installer selects one of **four levels to choose between speed and finish**. With the intelligent automatic control, the machine instantly analyses the needs of the disc, type and thickness of the material. Unlike manual settings based on guesswork, the DC-250 SMART ADVANCE ensures that every cut is perfectly even, as if guided by an expert hand.



## DC-250 SMART ADVANCE

**UNIQUE TILE SAW THAT AUTOMATICALLY ADAPTS ITS PERFORMANCE TO THE NEEDED JOB. THE REAL SMART CUT.**

For cutting all kind of ceramic tiles, Porcelain tiles and other materials.



CATEGORY: SUPERPRO

USE: PROFESSIONAL

WITH PLUNGE EFFECT



POWER  
1,5 cv/hp



1,5 cv/hp



3 1/2 in  
90 mm



CE

- **Two operating modes : Manual and Automatic. Different modes of Automatic cutting some favouring speed while other the quality of finish.**
- **Electronic Control to adapt engine power to the job needed. Uniform Cut with Perfect finish and no chipping.**
- **The machine adapts to the Blades needs and adjusts accordingly. Gives the Blades longer life and avoids glazing.**
- **Integrated protection system in the electronic control that stops and protects the engine in case the blade glazes or gets stuck.**
  - Motor (1,1 kW) assembly mounted on sliding bearings for maximum precision and reliability.
  - Direct drive motor.
  - Protection Bar for the driving belt.
  - Foldable at 45° for mitre.
  - Plunge effect allowing cutting height adjustment.
- Steel plate structure. Sturdy and maximum resistance to working conditions.
- Patented system ZERO DUST for a safe exposure to breathable dust particles generated during the cut.
- New cooling system. This allows to increase the cooling's EFFICIENCY and to reduce water dispersion. Includes blade and square alignment system with a regulation screw.
- Foldable legs with wheels for an EASIER transportation and removable tables for easy CLEANING of the machine.
- Adjustable aluminium square (0° – 60°) with lateral stop for REPETITIVE cuts at 0° and 45°.
- Safety blade PROTECTOR for TURBO and SEGMENTED blades that meets EU standard.
- 50W water pump with flow control.
- Supplied without cable (except US version).



**NEW!**



**3**  
YEARS  
WARRANTY

**1 2 3 4 5**  
Cut & Drill

REF.	⚡	RPM	↔	⏸	⬠	⚙	⚙	⚙	⚙	⚙	⚙	⚙	⚙	⚙
<b>DC-250 SMART ADVANCE 1200</b>	53913	230V-50Hz	2790	42 1/2" 108 cm	47 5/8" 121 cm	33 1/2x33 1/2" 85x85 cm	2 1/4/3 1/2" 58 / 88 mm	2 1/8" 55 mm	-	9 7/8" 250 mm	39 3/8x18 7/8x33 1/2" 100x48x85 cm	65 kg	79 kg	1
	53910	110V-50Hz												
	53912	220V-60Hz	3436											
	53911	120V-60Hz												

\*The cutting capacities can vary depending on the head position, special flanges and disc diameter.  
 \*\*The pictures of this product might be slightly different to its final version.

<b>ACCESSORIES</b>		<b>REF. 57941</b> Table Extension DV/DC/DCX/DS/DX		<b>REF. 51914</b> Roller Table Extension DU/DC/DCX/DS/DX (from 2013)		Cables with plug
--------------------	--	--	--	--	--	------------------

# DC-250 PYTHON

## MOVING HEAD MACHINE, VERSATILITY AND PRECISION

For cutting porcelain stoneware.



CATEGORY: SUPERPRO

USE: PROFESSIONAL

VERSATILITY



1.5 cv/hp



3 1/2 in  
90 mm



mm  
inch



PYTHON



- **Motor assembly mounted on sliding bearings for maximum precision and reliability. Foldable at 45° for mitre. Direct drive motor.**
- **Steel plate structure. Sturdy and maximum resistance to working conditions.**
- **Patented ZERO DUST system exclusive to RUBI and certified by TNO, for safe exposure because of reduction of respirable dust particles generated during cutting.**
- **C3 Python cooling system. New adjustable cooling system. Allows to adjust the point of water's fall depending on the material's thickness, getting a direct impact of the water in the cutting point. This allows to increase the cooling's efficiency and to reduce water dispersion.**
- Foldable legs with wheels for an easier transportation and removable tables for easy cleaning of the machine.
- Adjustable aluminium square (0° – 60°) with lateral stop for repetitive cuts at 0° and 45°.
- Safety protector for turbo and segmented blades.
- Blade cooling by water (50W water pump) with flow control.
- Includes diamond blade CEV-SUPERPRO Ø250 (\*Ref. 56949 includes CPA- SUPERPRO Ø250 blade).
- Supplied without cable.





**3**  
YEARS  
WARRANTY

**1** **2** **3** **4** **5**  
Cut & Drill

	REF.	⚡	RPM	↔	↙	⬠	✂	✂	⊙	⊙	⊙	⊙	⊙	⊙	⊙	⊙
<b>DC-250 PYTHON 850</b>	56941	230V-50Hz	2790													
	56937	220V-60Hz	3436	33 5/8" 85,5 cm	38 5/8" 98 cm	27 3/8x27 3/8" 69,5x69,5 cm			-		53 7/8x23 1/4x51 5/8" 137x59x131 cm	120.1507 lb 54,5 kg	153.2197 lb 69,5 kg			
	56938	110V-50Hz	2790						√							
<b>DC-250 PYTHON 1200</b>	56939	230V-50Hz	2790				2 3/8/3 1/2" 61/90 mm	2 1/8" 55 mm		9 7/8" 250 mm				1	**1	
	56943	220V-60Hz	3436	42 1/2" 108 cm	47 5/8" 121 cm	33 1/2x33 1/2" 85x85 cm			-		63 3/4x32 1/4x51 5/8" 162x82x131 cm	131.28393 lb 59,55 kg	165.345 lb 75 kg			
	56947	110V-50Hz	2790													
	56949	230V-50Hz	2790						√							

The cutting capacities can vary depending on the head position, special flanges and disc diameter.

ACCESSORIES			
	<b>REF. 57941</b> Table Extension DV/DC/DCX/DS/DX		<b>REF. 51914</b> Roller Table Extension DU/DC/DCX/DS/DX (from 2013)
			Cables with plug

## DWD-125 DUO CUT

### HYBRID BRIDGE TILE SAW TO PERFORM WET AND DRY CUTS.

For professional cutting all kind of ceramic tiles, Porcelain tiles and occasional cut of natural stone such marble or granite.



CATEGORY: PREMIUM



USE: PROFESSIONAL



WITH PLUNGE EFFECT



POWER  
>1,5 cv/hp\*



1,5 cv/hp



11 3/4 in  
30 cm



49 1/4 in  
125 cm



- **Double cutting mode. Dry Cutting:** blade cover connected to dust extractor. **Wet cutting:** double spray blade cooling system.
- **Fixed square. Assembled with magnets. With lateral side stop for repetitive and diagonal cuts. Detachable and easy storage inside the same chassis.**
- **Light and compact. Central beam (mono chassis type). Folded chassis width 50cm - Easy to transport and move through narrow spaces.**
- **Greater stability thanks to the pyramidal design of the legs. Individual adjustment on each leg to adapt to work area. Equipped with fast block system.**
- Rotating side table. Easy to mount and adjust, no tools needed. Telescopic and folding lateral leg for a perfect levelling to the floor. Possibility to mount in both sides of the machine.
- Motor assembly mounted on sliding bearings for maximum precision and reliability.
- Brushless motor. Power equivalence to Universal motor of 1,8 kW. Direct drive motor.
- Foldable arms at 45° for mitre.
- Plunge effect allowing cutting height adjustment.
- Made in aluminium and plastic to make it lighter and high rusting resistance.
- Patented zero dust system for a safe exposure to breathable dust particles generated during the cut.
- C3 Hydra cooling system. Allows to increase the cooling's efficiency and to reduce water dispersion.
- Rubber strips on top of the table to gain tiles fixation and stability.
- Supplementary table adjustable at 0-45-90-135-180°. Allows to have an extra width of support from 350 (0°/180°) to 900mm (90°)
- Equipped with plastic handle, rubber wheels (Ø100 mm) and bumpers for an EASIER transportation.
- Safety blade Protector for Turbo and Segmented blades that meets EU standard.
- Supplied without cable and without blade.



**NEW!**



**3**  
YEARS  
WARRANTY

**1 2 3 4 5**  
Cut & Drill

REF.		RPM												
<b>DWD-125 DUO CUT 1250</b>	59906	220/240V-50/60hz	6000	49 1/4" 125 cm	-	34 5/8x34 5/8" 88x88 cm	11 3/4" 30 cm	-	7/8"	4 7/8" 125 mm	75 5/8x30 3/4x46 1/2" 192x78x118 cm	88.184 lb 40 kg	1	1**
	59907	110/130V-50/60hz							22.2 mm					
	59911	110-130V 50-60HZ							5/8"					

\*Real power of the Brushless motor is 900W, but this is equivalent to a 1600W Universal motor.  
 \*\*The pictures of this product might be slightly different to its final version.

ACCESSORIES		REF. 05973 Cleaning Block		REF. 05974 N-Cleaning Block		Cables with plug



**NEW**

**DL-125 · 1200**

—  
The new light and versatile  
table saw





Introducing the DL-125 electric table saw, your lightweight, robust, and easy to transport tile cutter. It combines **power** (2.4 HP motor) and **portability** (only 48 kg), making it ideal for jobs where space is limited. Its wide range of cutting sizes (up to 3cm thick and 135cm long) make it a highly **versatile** tool.

Its small 125mm blade, coupled with its bridge structure, guarantees precision and efficiency, while its adjustable feet, wheel, and handle make it easy to transport. It also includes a dust reduction system for a cleaner working environment. Perfect for tilers and builders looking for **quality and ease of use**.



## DL-125

**MOBILE HEAD CUTTER, POWERFUL, LIGHT AND TRANSPORTABLE.**

Suitable for intensive cutting of porcelain and all kinds of ceramic tiles. Occasional cut of natural stone.

CATEGORY: SUPERPRO

●●○  
USE: PROFESSIONAL



LIGHT



TRANSPORTABLE



- **35 cm wide extruded aluminium chassis, ideal for small workplaces.**
- **Wheels and handle for easy transport, as well as height-adjustable legs for stability.**
- **Equipped with blade adjustment system.**
- **Multiple accessories included with the machine.**
  - Electric machine with cutting effect.
  - Motor set mounted on bearings for maximum precision and reliability.
  - 1800W (2.4CV) universal motor.
  - 125mm diamond blade TVR included (cutter compatible with 115–130mm blades).
  - Reinforced aluminium chassis (double beam system). Improves the stability and rigidity of the chassis.
  - Safety protection system for Blades.
  - Equipped with ZERO DUST system.
  - Removable water tank for easy cleaning (8L).
  - Ergonomic transport and adjustment improvements (motor adjustment, support adjustment, carriage wheel adjustment).
  - Accessories included: Double lateral extension, repetitive cuts, laser and lateral stop for repetitive cuts included (adjustable from 8mm to 20mm tiles).
  - The machine is supplied without cable.



**NEW!**



**3**  
YEARS  
WARRANTY

**1 2 3 4 5**  
Cut & Drill

REF.	⚡	RPM	↔	👁️	📐	✂️	🔪	🌀	🌀	🌀	📏	📏	📏	📏	📏	📏	📏	📏	
<b>DL-125 1200</b>	56924	220-240V 50/60Hz	12.000 max	48 7/8" 124 cm	53 1/8" 135 cm	35 3/8x35 3/8" 90x90 cm	1 1/8/1" 30 / 50 mm	3/4"	√	7/8" 22.2 mm	4 7/8" 115-130 mm	69 5/8x18 1/2x51 5/8" 177x47x131 cm	105.82 lb 43 kg	1	**1				

The cutting capacities can vary depending on the head position, special flanges and disc diameter.

ACCESSORIES		REF. 05973 Cleaning Block		REF. 05974 N-Cleaning Block		Cables with plug



## DV-200

**MOBILE HEAD ELECTRIC CUTTER OF MAXIMUM FUNCTIONALITY AND RELIABILITY**

For all types of ceramic and porcelain tiles and other materials.



CATEGORY: SUPERPRO

USE: PROFESSIONAL

MITRE CUT (45°)



CE

EAC

- **Set motor on sliding bearings for maximum accuracy and cut quality.**
- **C<sup>3</sup> System, improves blade's cleaning and cooling for a higher performance.**
- **Removable aluminium tables for easy cleaning of the machine.**
- **Folding legs with built-in wheels for a more comfortable transport.**
- Includes diamond disc CEV PRO Ø 200 mm.
- Direct motor, single phase 1.1 kW (1.5 HP) with thermal protector.
- Water pump cooling of blade with flow control
- Reinforced chassis, greater structural rigidity.
- Adjustable lateral stop (0 ° to 60 °) for repetitive cuts.
- Large work area (100x48,5cm) suitable for large formats.
- Working height of 84.5 cm. for improved user ergonomics.
- Double Switch (ON/OFF) quick and easy access.
- Foldable head at 45° for mitre cuts that can cut up to 106 cm length.
- Front blade cooling diffuser with 5 positions depending on the hardness or the abrasion of the material.
- Machine supplied without cable.





REF.			RPM									
DV-200 1000	54911	230V-50 Hz.	2790	41 3/4" 106 cm	1 3/8" 35 mm	5/8" 15 mm	√	7 7/8" 200 mm	62 x23 1/4x46 1/8" 160x59x117 cm	133.3783 lb 60,5 kg	1	**1
	54913	110V-50Hz.										
	54914	120V-60Hz.										

The cutting capacities may vary depending on the position of the head, special flanges and disc diameter.

ACCESSORIES		<b>REF. 54999</b> Laser & Level Kit DV/DC/ DCX/DS/OX		<b>REF. 51916</b> Tile Fixer DV/DC/DCX/ DS/OX		<b>REF. 57941</b> Table Extension DV/DC/ DCX/DS/OX



## DU-200 EVO

**MOBILE HEAD CUTTER FOR RENOVATIONS AND LIGHT WORKS.**

To cut ceramic and porcelain wall and floor tiles.



  
CATEGORY: PRO

  
USE: OCCASIONAL

  
LIGHT

  
TRANSPORTABLE

PATENTED



- **Built-in foldable legs. Very easy to fix.**
- **With wheels and handle for a more comfortable transport and handling.**
- **External water tank, easy to handle and clean.**
- **C<sup>3</sup> System, improves blade's cleaning and cooling for a higher performance.**
- Motor assembly mounted on sliding bearings and foldable for mitre cuts.
- With lateral stop for repetitive cuts and adjustable square from 0 to 45°.
- Direct drive motor with thermal protector and reinforced chassis.
- Corrugated tube to protect power cable and water pipe.
- Front blade cooling diffuser with 5 positions depending on the hardness or the abrasion of the material.
- Bi-material handle, better ergonomics.
- With CEV-SUPERPRO diamond disc Ø 200 mm.



REF.		RPM										
<b>DU-200 EVO 650</b>	55903	230V-50Hz.	2915	25 5/8" 65 cm	17 3/4x17 3/4" 45x45 cm	1 3/8" 35 mm	3/4" 20 mm	√	7 7/8" 200 mm	46 1/8x15 3/8x40 1/8" 117x39x102 cm	49.6035 lb 22,5 kg	1
	55905	230V-50Hz. UK										
	55906	110V-50Hz. UK	2670									
	55907	120V-60Hz. USA	3200									
	55938	220V-60Hz.	3490									
<b>DU-200 EVO 850</b>	54975	230V-50Hz.	2915	33 1/2" 85 cm	23 5/8x23 5/8" 60x60 cm	1 3/8" 35 mm	3/4" 20 mm	√	7 7/8" 200 mm	53 1/2x15 3/8x40 1/8" 136x39x102 cm	59.96512 lb 27,2 kg	6
	54977	230V-50Hz. UK										
	54976	120V-60Hz. USA	3490									

The displayed product may not correspond exactly with the actual model.

<b>ACCESSORIES</b>		<b>REF. 05973</b> Cleaning Block		<b>REF. 05974</b> N-Cleaning Block



# NUEVA DT-250 MAX

Fast cutting for outdoors





Discover the DT-250 MAX, the ideal intensive wet cut for ceramic, porcelain, stone, and landscaping materials. This electric cutter is the perfect solution for professionals looking for **fast and precise outdoor cutting**, with mitre and plunge capabilities, and a large support table that allows you to work with tiles up to 125x125 cm.

Its advanced water management, with a tank of up to 19 L, includes the **ZERO DUST** system, an innovation that ensures a **safe working environment free of dust and water particles**.

A compact and powerful electric tile cutter, ideal for making the perfect cut wherever you need it.



## DT-250 MAX

### TRANSPORTABLE ELECTRIC CUTTER WITH MITRE EFFECT. GOOD FINISH.

For cutting stoneware, tiles, ceramics, refractories and other materials.



  
CATEGORY: SUPERPRO

  
USE: PROFESSIONAL

  
TRANSPORTABLE

FAST



- Python cooling system combined with the Zero Dust system, keeps your work area clean by reducing the production of splashes.
- It incorporates a tubular steel support with wheels and foldable, to transport the machine easily.
- With lateral stop for repetitive cuts with adjustment from 0° to 45° and magnetic support for the blade key.
- Diamond blade for fast, smooth cuts with a long service life.
- Laser indicator to facilitate ceramic placement and obtain more precise cuts.
- Tilting cutting head adjusts for precise 22.5° and 45° bevel cuts.
- Tank with level indication min. and max. Maximum capacity: 19 l.
- It incorporates an aluminium table with a rubber surface with a cutting capacity of 90 cm.
- Available accessory Ref. 58916 that extends the table up to 120 cm.



**NEW!**



**3**  
YEARS  
WARRANTY

**1 2 3 4 5**  
Cut & Drill

REF.	⚡	RPM	↔	⬠	⬢	⬡	⬢	⊕	⊖	⊕	⊖	⊕	⊖
<b>DT-250 MAX</b>	58909	220/240 V - 50/60 Hz	4000	35 3/8" 90 cm	23 5/8" 60 cm	3 1/2" 90 mm	25 mm	1 1/8" 25,4 mm	9 7/8" 250 mm	62 x368 1/8x48 3/8" 160x935x123 cm	99.207 lb 45 kg	1	4
	58915												
	58913	110/130 V - 50/60 Hz											

The cutting capacities can vary depending on the head position, special flanges and disc diameter.

<b>ACCESSORIES</b>		<b>REF. 58916</b> EXTENDABLE TABLE DT - 250 MAX		<b>REF. 58917</b> Set of flanges for DT-250 MAX



## DR-350

### ELECTRIC SAW WITH PLUNGE EFFECT.

For all types of building materials like: masonry bricks, facade bricks, fireproof bricks, marble, granite and ceramic tiles.



CATEGORY: SUPERPRO

USE: INTENSIVE

POWER

IDEAL CUTTING WORK MATERIAL



- **Head with high performance plunge effect. Large cutting capacity.**
- **Equipped with ZERO DUST system. Tested and certified by TNO.**
- **Large table for a larger work surface and comfort.**
- **Steel structure robustness. Increased resistance to the demands of intensive work.**
- Equipped with protective safety system for segmented blades.
- With thermal protector.
- Adjustable head to 45°.
- Large table 23 1/16"x19 1/2" (58.5x49.5cm).
- Blade cooling by water pump with integrated regulation valve.
- Diamond blade Ø12-14" (300-350mm) not included.
- Machine supplied without cable.
- Direct drive motor.
- Supplied with new ZERO DUST system already assembled. Also provided with a second anti-splash standard protector.





REF.	⚡	RPM	↔	↶	⬠	⊞	⊞ <sup>2</sup>	⊞	⊞	⊞	⊞	⊞	⊞	⊞		
<b>DR-350</b>	56940	230V-50 Hz	2800	28 1/8" / 71,5 cm	33 1/8" / 84 cm	17 1/8x17 1/8" / 43,5x43,5 cm	∞" / ∞ cm	3 3/4/5 7/8" / 95 / 150 mm	-	11 3/4-13 3/4" / 300-350 mm	45 1/4x27 1/8x52 1/8" / 115x69x132,5 cm	138.89 lb / 63 kg	175.27 lb / 79,5 kg	√	1	1

The cutting capacities may vary depending on the position of the head, special flanges and disc diameter.

ACCESSORIES				
		REF. 05974 N-Cleaning Block		REF. 05975 Cleaning Block
				Cables with plug





# ND-200

**PORTABLE CUTTER, IDEAL FOR FINISHINGS AND RENOVATIONS.**  
For cutting ceramic tiles and other materials.



**CATEGORY: PRO**  
Category

**USE: OCCASIONAL**  
Use

**LIGHT**

**DURABILITY**



- **Lightweight and compact, ideal for working in small spaces.**
- **Stainless steel folding table. More durability.**
- **Fast positioning system at 45°. Easy to use.**
- **Removable disk protector for vertical cuts. Simplifies creation of light boxes, frames, etc...**
- CEV-PRO Ø8" (200mm) diamond blade included.
- Water cooling of the blade.
- Lateral stop to allow repetitive cuts.
- Electric cable: 4.9ft (1,5m).
- Direct drive with thermal protector.

	REF.	⚡	RPM	↔	⬠	⬠	⬠	⬠	⬠	⬠	⬠	⬠	⬠							
<b>ND-200</b>	45910	230V-50 Hz.	2790	∞"	∞"	9 1/8"	1 5/8"	√	7 7/8"	20 1/8x20 5/8x9 1/2"	37.91912 lb	1	8							
	45915	230V-50 Hz.UK																		
	45911	220V-60 Hz.	3240											∞ cm	∞ cm	23 cm	40 mm	200 mm	51x52,5x24 cm	17.2 kg
	45916	110V-50 Hz.UK	2750																	

The cutting capacities may vary depending on the position of the head, special flanges and disc diameter.

**ACCESSORIES**

**REF. 05974**  
N-Cleaning Block

**REF. 05973**  
Cleaning Block



# ND-180 SMART

## PORTABLE ELECTRIC CUTTER.

Ideal for Wall and Floor tiles. Perfect for repairs and renovations.



**CATEGORY: PRO**

**USE: OCCASIONAL**

**LIGHT**



- **Water cooling of the blade.**
- **With foldable table for mitre cutting up to 7 7/8" (20cm).**
- **With lateral stop for repetitive cuts.**
- **Guide for 45° cuts.**
- DIRECT drive SINGLE PHASE motor.
- WET cut.
- LIGHT for a comfortable work.
- EASY to use.
- 1.5 m electric cable.
- FOLDABLE table for mitring cuts.
- INCLUDES:
- Ø180 mm. diamond blade, CEV-PRO type.
- Lateral stop for repetitive cuts and 45°.

	REF.			RPM									
ND-180 SMART	24976	√	230V-50 Hz.	2800	∞	∞	3/4" 20 mm	1 3/8" 34 mm	7 1/8" 180 mm	15 1/8x15 1/2x6 3/4" 38,5x39,5x17 cm	1940048 lb 8.8 kg	1	24
	24979		230V/50Hz								21.23 lb 9.63 kg		
	24977		120V/60Hz	3600									

The breaking capacities may vary depending on the position of the head, special flanges and disc diameter.

**ACCESSORIES**

REF. 05973  
Cleaning Block

REF. 05974  
N-Cleaning Block

# ACCESSORIES FOR ELECTRIC CUTTERS

**2**  
 Cut & Drill

 CATEGORY:  
 SUPERPRO

## CLEANING BLOCK

- For cleaning of diamond blades.

REF.



CLEANING BLOCK	05973	5
----------------	-------	---

 CATEGORY:  
 SUPERPRO

## N-CLEANING BLOCK

- Specifically designed to bring back the diamonds on the rim of diamond blades when cutting porcelain.

REF.



N-CLEANING BLOCK	05974	5
------------------	-------	---

 CATEGORY:  
 SUPERPRO

## SET OF FLANGES FOR MITRING CUTS.

- To reduce saw flex in mitre cuts.
- Available in several models.
- Flange for reinforced saws.

REF.



SET OF FLANGES Ø184MM DX-350	51915	1
SET OF FLANGES Ø170MM DC PYTHON/DCX	51927	
SET OF FLANGES Ø130MM DV/DC/DCX/DX-250	57991	
SET OF FLANGES FOR DT-250 MAX	58917	

 CATEGORY:  
 SUPERPRO



## TABLE EXTENSION

- Increases work surface for large format tiles. 23 5/8" (600x280mm).
- Maximum weight: 33Lb. (15kg).
- Compatible with various models of cutting machines.

REF.

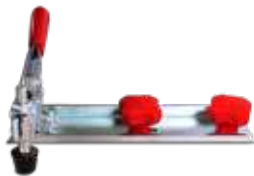

TABLE EXTENSION DV/DC/DCX/DS/DX	57941	1
---------------------------------	-------	---

 CATEGORY:  
 SUPERPRO

## TILE FIXER DV/DC/DCX/DS/DX

- Allows the fixing of the tile during cutting, thus avoiding sudden movements.
- Accessory adaptable to DV,DC,DS and DX series (up to 2009).

REF.



TILE FIXER DV/DC/DCX/DS/DX	51916	1
----------------------------	-------	---

 CATEGORY:  
 SUPERPRO

## ROLLER TABLE EXTENSION

- With rollers to simplify movement of the tiles.
- With adjustable foldable legs.
- Work surface 26 9/16"x22 5/8" (675x575mm) and maximum weight 154lb (70kg).
- Installation on both sides of the machine.

REF.



ROLLER TABLE EXTENSION DU/DC/DCX/DS/DX (FROM 2013)	51914	1
--	-------	---

▲ CATEGORY:  
SUPERPRO



### DT-250 MAX TABLE EXTENSION

- For better grip of large tiles with a cutting capacity of up to 120 cm.
- Exclusive for DT -250 MAX.
- Extendable legs included to prevent tipping of the support.
- Main table manufactured in aluminium with a rubber layer.
- Guides manufactured in extruded aluminium with reinforcing cross-bars.

REF.



EXTENDABLE TABLE DT - 250 MAX	58916	1
-------------------------------	-------	---

▲ CATEGORY:  
SUPERPRO



### ADJUSTABLE LENGTH LATERAL STOP DC/DCX/DS/DX

- For fixing large format tiles.
- Adjustable to the maximum length of electric cutter.
- Tile is held laterally thus avoiding any movement.
- Especially suitable for blocking and execution of repetitive mitre.

REF.



ADJUSTABLE LENGTH LATERAL STOP DC/DCX/DS/DX	54844	1
---	-------	---

▲ CATEGORY:  
SUPERPRO



### LATERAL STOP FOR DC/DCX/DS/DX

- Facilitates positioning of the tile, while reducing the percentage of errors.

REF.



LATERAL STOP FOR DC/DCX/DS/DX	54822	1
-------------------------------	-------	---

▲ CATEGORY:  
SUPERPRO



### LASER & LEVEL KIT DV/DC/DCX/DS/DX

- Kit includes:
- Circular bubble level to facilitate proper positioning of the electric cutter.
- Laser Tracer indicating the passage of the disc and facilitates placement of material.
- Laser power: 2 mW
- Laser Class: 2
- Not compatible with DC-250 PYTHON models.

REF.



LASER & LEVEL KIT DV/DC/DCX/DS/DX	54999	1
-----------------------------------	-------	---

▲ CATEGORY:  
SUPERPRO



### CABLES WITH PLUG

- For machines supplied without cable, please include both the reference of the machine and the reference of the correct voltage cable with plug which is suitable for the Country of destination.
- Approximate length 3.5m.

REF.



	REF.		
CABLE WITH PLUG 230/50 EUR	58850	230V - 50 Hz EUR	1
CABLE WITH PLUG 110/50 UK	58852	110v-50 Hz UK	
CABLE WITH PLUG 230/50 UK	58853	230V-50 Hz UK	
CABLE WITH PLUG 120/60 15A 12AWG USA	58854	120V-60 Hz 15A 12AWG USA	
CABLE WITH PLUG 220/60 15A 12AWG USA	58856	220V-60 Hz 15A 12AWG USA	
CABLE WITH PLUG 230/50 10A AUS	58863	230v - 50 Hz 10A AUSTR.	
CABLE WITH PLUG 120/60 30A 10AWG USA	58869	120V-60 Hz 30A 10AWG	



# CIRCULAR SAW TC-180

## PRECISE CUTTING ON LARGE FORMAT MATERIALS.

For dry and wet cutting of ceramic, porcelain and other materials.



**CATEGORY: SUPERPRO**

**VERSATILITY**

**LIGHT**

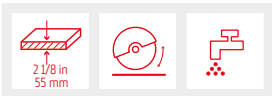

- **Practical cutter and easy to use for large pieces.**
- **Double cooling system, wet and dry. Greater adaptability to environment.**
- **Guiding mark for better visibility of the line of cut.**
- **Easy adjustment of cutting thickness. Greater versatility and adaptability to the different materials.**
- Especially suitable for large pieces.
- Allows the user to reduce manipulation, handling heavy or awkward use.
- Content:
  - Blade Ø180mm TCR-180 SUPERPRO.
  - Parallel guide.
  - Cable with PRCD switch (differential).
  - Cone reducer for vacuum cleaner.
  - Transport case.

	REF.		RPM	W											
<b>TC-180</b>	50939	✓	5800	1800 1800 W	230V / 50-60Hz	2 1/8" 55 mm	7 1/8" 180 mm	7/8" 22.2 mm	12 x17 3/4x14" 33x45x38 cm	✓	14.77 lb 6.7 kg	24.2506 lb 11 kg	1	-	

**ACCESSORIES**



TC-180 Guides



REF. 50957  
Guide connector



REF. 50958  
Fixing C-clamp



**CATEGORY: SUPERPRO**



**CIRCULAR SAW TC-180 KIT**

- Kit includes:
- 1 x Circular Cutter TC-180 230V 50/60Hz (Ref. 50939), 1 x Blade TCR-180 (Ref. 31975), 2 x Guide 80 cm. for TC-180 (Ref. 50956), 1 x Connector guides (Ref. 50957), 2 x Fixing Clamps (Ref. 50958).

	REF.		
<b>TC-180 230V/50-60HZ KIT</b>	50994	1	8

**CATEGORY: SUPERPRO**



**TC-180 GUIDES**

- Aluminium Guide for straight cuts.
- Ability to connect multiple guides through the connector (Ref. 50957).

	REF.			
<b>80CM GUIDE FOR TC-180 (31 1/2")</b>	50956	32 1/4x7 1/4x3/4" 82x18.5x2 cm	2.77796 lb 1.26 kg	1
<b>120CM GUIDE FOR TC-180 (47 1/4")</b>	50959	47 5/8x7 1/8x3/4" 121x18x2 cm	3.96828 lb 1.8 kg	

**CATEGORY: SUPERPRO**



**GUIDE CONNECTOR**

- Allows the connection of multiple guides to increase cutting length.

	REF.	
<b>GUIDE CONNECTOR</b>	50957	1

**CATEGORY: SUPERPRO**



**FIXING C-CLAMP**

- Highly recommended for fixing the guide on the tile and preventing movement through out the cut, thus achieving a cleaner cut.

	REF.	
<b>FIXING C-CLAMP</b>	50958	1



# ANGLE GRINDER TECH

## EFFICIENT AND VERSATILE.

Battery powered angle grinder for dry cutting, drilling or grinding of ceramic and porcelain tiles, natural stone or other materials.



**NEW!**

**CATEGORY: PREMIUM**

**USE: PROFESSIONAL**

**CAS BATTERY COMPATIBLE**



COMPATIBILITY	
RUBIMIX E-9 ENERGY CAS	18 V 5.2 Ah
RUBIMIX E-10 ENERGY CAS	18 V 5.2 Ah
ANGLE GRINDER TECH	18 V 5.2 Ah
RUBI LUMED	18 V 5.2 Ah
QUAKE ENERGY CAS	18 V 2.0 Ah
RUBI TRILLER ENERGY CAS	12 V 4.0 Ah



- **BRUSLESS MOTOR.** Highest efficiency and maximum handiness.
- **CAS PLATFORM TECHNOLOGY.** Li-Power 18V 5,2 Ah CAS battery. Portability and manageability, free of cables.
- **TOOL-FREE ADJUSTABLE GUARD.** Twist-proof.
- **SLIM DESIGN** for low-fatigue working. Handle circumference **183 mm**.
- Electronic safety shutdown reduces kickback if the disc stops unexpectedly - for high user safety.
- Overload protection protects the motor from overheating.
- Electronic soft start for smooth start-up.
- Restart protection prevents unintentional start-up after battery pack change.

	REF.		RPM				
<b>RUBI ANGLE TECH ENERGY CAS EU (W/O BATTERY+CHARGER)</b>	52949	18 18 V	10000	4 7/8" 125 mm	7/8" 22 mm	4.85012 lb 2,2 kg	-
<b>BATTERY CASE LI-POWER 18V 5.2AH</b>	85902	18V					1

\*The pictures of this product might be slightly different to its final version.



## CHARGER ENERGY CAS

2  
Cut & Drill

NEW!





CATEGORY: PREMIUM

CAS CAS BATTERY COMPATIBLE

## CHARGER ENERGY CAS

- To charge all LiPOWER and LiHD sliding connection batteries (12 V-18 V), with adapted battery charging current.
- 3-year warranty.
- Approximate charging time: 30 minutes for 1.5 Ah.
- "AIR COOLED" function.
- For charging all Li-Power Compact, Li-Power Plus, Li-Power Extreme batteries.

	REF.		
CHARGER ENERGY CAS EU	26575	1	12-18 12-18 V
CHARGER ENERGY CAS UK	26576		
CHARGER ENERGY CAS USA	26577		
CHARGER ENERGY CAS AUS	26578		

## ACCESSORIES DIAMOND BLADES

2  
Cut & Drill

NEW!



CATEGORY: SUPERPRO

USE: PROFESSIONAL

## CUT MASTER GUIDE

- To increase the stability and comfort when cutting. Improves the quality of the cut and the performance of the blade.
- The connection to vacuum cleaner completely removes dust from the cutting zone. Silicone seal does not allow dust leaks.
- Fits all models of an angle grinder Ø115, Ø125 mm. It is not needed to remove original blade protector.
- Wheels holds the weight of the angle grinder when cutting. It is much easier to guide the blade in a straight line.
- Vacuum cleaner connector Ø35 mm.
- Rubber wheels of Ø30 mm that not marks the tile.

	REF.	
CUT MASTER GUIDE 90°	40922	1

## PRO-EDGER BEVELLING AND MITRING ACCESSORY

**PROFESSIONAL PORTABLE SYSTEM FOR INTENSIVE USE, ESPECIALLY DESIGNED FOR DRY BEVELLING AND MITRING PRINCIPALLY OF LARGE FORMAT TILES.**

It can bevel and mitre porcelain, ceramic and any natural stone material of any length.



CATEGORY: SUPERPRO



TRANSPORTABLE



LIGHT



- It makes mitre cuts at 45° up to a maximum thickness of 20 mm, and with no thickness limitation for beveling.
- Progressive beveling and mitring at different depths to prolong the useful life of the grinding wheel and make beveling easier for the user.
- Compatible with 115 & 125mm angle grinders with cable or battery that are easily and safely fitted thanks to the joint made with an M14 threaded shaft and quick-fastening belt.
- Sealed high-speed bearings, to prevent the ingress of dust generated during the beveling or mitring.
- Highly wear-resistant white polyethylene slides.
- A vacuum cleaner can be easily fitted for dust extraction (ZERO-DUST).
- Quick and simple grinding wheel change.
- Chassis with carbon steel sheet.
- 45° x 20 mm grinding wheel included (ref. 16946).
- Fixing to angle grinder by means of a Ø14mm (Ref. 16956) and 5/8"-11" (Ref. 16901) and quick fastening belt.
- Progressive wear beveling and mitring is adjustable by 10 mm.
- A damp cloth is recommended for cleaning.
- Water is not necessary for use.
- Includes a bag with pockets for tools as a gift.



	REF.									
<b>PRO-EDGER PORTABLE BEVELLING</b>	16956	√	∞°	3/4"	M14"	14 x8 1/4x6 3/4"	9.03886 lb	9.9207 lb	1	24
<b>PRO-EDGER PORTABLE BEVELLING USA</b>	16901		∞ cm	20 mm	M14 mm	38x21x17 cm	4.1 kg	4.5 kg		

ACCESSORIES		Fine Grit PRO-EDGER beveling Wheel		Fine Grit PRO-EDGER mitering Wheel		Turbo Twist Coarse Grit PRO-EDGER mitering Wheel



## ACCESSORIES FOR BEVELLING AND MITRING

2  
Cut & Drill

CATEGORY: SUPERPRO

MATERIAL: PORCELAIN TILE

GOOD FINISH

## FINE GRIT PRO-EDGER BEVELLING WHEEL

- Grinding wheel for beveling.
- Diamond grits fixed by means of a vacuum brazing system.
- Recommended for use with ANGLE GRINDERS.
- Recommended use between 9,000 – 12,000 rpm to achieve greater durability of the wheel.
- Round finish available on 5 and 10 mm radius.
- Internal diameter: 16.1 mm (M16 thread).
- For exclusive use with PRO-EDGER.

	REF.				RPM	
<b>R.5 FINE GRAIN PRO-EDGER BEVELLING WHEEL</b>	16957	2 5/8" 66 mm	M16*	1/4" 6 mm	12000 max.	5
<b>R.10 FINE GRAIN PRO-EDGER BEVELLING WHEEL</b>	16958	2" 76 mm	M16 mm	3/8" 11 mm		1



CATEGORY: SUPERPRO

MATERIAL: PORCELAIN TILE

GOOD FINISH

## FINE GRIT PRO-EDGER MITRING WHEEL

- Grinding wheel for mitring.
- Diamond grits fixed by means of a vacuum brazing system.
- Recommended for use with ANGLE GRINDERS.
- Recommended use between 9,000 – 12,000 rpm to achieve greater durability of the wheel.
- 45° type tool with 1-2 mm edge.
- Internal diameter: 16.1 mm (M16 thread).
- For exclusive use with PRO-EDGER.

	REF.				RPM	
<b>45X20 FINE GRAIN PRO-EDGER MITRING WHEEL</b>	16946	3 3/4" 94 mm	M16*	3/4" 20 mm	12000 max.	5
<b>45X15 FINE GRAIN PRO-EDGER MITRING WHEEL</b>	16985	3 1/4" 84 mm	M16 mm	5/8" 15 mm		



CATEGORY: SUPERPRO

MATERIAL: PORCELAIN TILE

FAST

## TURBO TWIST COARSE GRIT PRO-EDGER MITRING WHEEL

- Grinding wheel for mitring.
- Diamond grits fixed by means of a vacuum brazing system.
- Recommended for use with ANGLE GRINDERS.
- Recommended use between 9,000 – 12,000 rpm to achieve greater durability of the wheel.
- The TURBO TWIST model can be used for grinding before finishing with a fine grit, as its grooved design can chip the tile profile.
- Internal diameter: 16.1 mm (M16 thread).
- For exclusive use with PRO-EDGER.

	REF.				RPM	
<b>45X15 TURBO TWIST COARSE GRAIN PRO-EDGER MITRING WHEEL</b>	16984	3 1/4" 84 mm	M16* M16 mm	5/8" 15 mm	12000 max.	5



# MITRE-MATE

## HIGH QUALITY MITRE CUT.

Accessory for mini angle grinders (Ø115/Ø125) to make mitre cuts on the edge of tiles.







**CATEGORY: SUPERPRO**



**USE: PROFESSIONAL**





**MITRE CUT [45°]**



**GRINDER**

- **Sliding it along the edge of the tile, thanks to the horizontal sliding surface and the bearings that allow a smooth advance during cutting.**
- **By sliding the tile. The machine can be clamped in an inverted position on the SLAB\* tables. The machine is held in place and the tile can be slid into position. Particularly suitable for repetitive cutting.**
- **PERFECT FINISHING, thanks to the precise cut adjustment function, the large support surface and the bearings that allow perfect sliding.**
- **Suction connection compatible with most vacuum cleaners.**
- Easy and quick to transport and install, no guides required.
- Types of anchor for grinder: M14 or 5/8"-11
- Specially designed for dry cutting. Allows wet cutting for angle grinders with IP65.
- Dust extractor connector with various diameters (Ø37/42/49 mm).
- Safety band for fixing the grinder.
- Compatible with most angle grinders (Ø115/125) on the market.
- Includes TVR-125 SUPERPRO diamond blade.

	REF.				
MITRE-MATE	52825	3/4" 20 / 25 mm	√	4 1/2/4 7/8" 115 / 125 mm	1
MITRE-MATE USA	52826				

\*Compatible with the SLAB TABLE (both versions) and exclusively with the SLAB TABLE VERSATILE.

\*\*The pictures of this product might be slightly different to its final version.

# RUBI CLEAR DUST EXTRACTOR M

## WET AND DRY VACUUMING WITH THE SAME MACHINE AND SPECIFIC ACCESSORIES FOR OPTIMISATION.

For dry and wet extraction work in areas where very fine dust is generated by cutting, such as hardwood, paint, plastics, cement and brick (type M dust).







  
CATEGORY: PREMIUM

TYPE M CERTIFICATE

AUTOCLEAN



- Autoclean system that automatically shakes the filter.
- M- Class certified, it vacuums up 99.9% of airborne particles, including wood (hard and soft), plaster, plasterboard, Corian, paint, plastics, cement and brick.
- Power socket for automatic start and stop in synchronisation with the tool being used (2000 W max.).
- Metal wheels reinforced with rubber and with an optimum radius for moving on uneven ground.
- Agile and compact. 20L tank and an extra-long handle.
- Included:
  - Blue anti-foam filter for vacuuming liquids.
  - 3-metre suction hose.
  - Extendable plastic tube.
  - two multifunctional brush bases.
  - Brush for hard floors.
  - Brush for working with liquids.
  - Flat nozzle for corners.
  - Rubber adapter.
- Consumables included:
  - Three 20L bags.
  - M- Class polyester cartridge filter.

	REF.					
<b>RUBI CLEAR DUST EXTRACTOR M</b>	51941	230V-50Hz	157 1/2x157 1/2x236 1/4" 400x400x600 cm	22.046 lb 10 kg	1	12
<b>RUBI CLEAR DUST EXTRACTOR M UK</b>	53500	230V-50Hz				-

### ACCESSORIES



REF. 51997  
RUBI CLEAR DUST  
EXTRACTOR BAG (5 UN)



REF. 51989  
RUBI CLEAR DUST  
EXTRACTOR FILTER



REF. 52947  
CLEAR VACUUM CLEANER  
WET FILTER

**CATEGORY:  
PREMIUM**

### RUBI CLEAR DUST EXTRACTOR BAG (5 UN)

- Filter bag for M-Class dust extraction.
- Designed specifically for the Clear vacuum cleaner.
- Closure designed for proper waste management and subsequent sealing (regulated in the cleaner's M-Class certification).
- Pack of 5 units.
- IFA certification.

REF.



RUBI CLEAR DUST EXTRACTOR BAG (5 UN)	51997	15
--------------------------------------	-------	----

**CATEGORY:  
PREMIUM**

### RUBI CLEAR DUST EXTRACTOR FILTER

- Filter for dry vacuuming and M- Class filtration.
- Specifically designed for the Clear vacuum cleaner.
- IFA certification.

REF.



RUBI CLEAR DUST EXTRACTOR FILTER	51989	1
----------------------------------	-------	---

**CATEGORY:  
PREMIUM**

### CLEAR VACUUM CLEANER WET FILTER

- Filter for wet vacuuming.
- Specifically created for the Clear vacuum cleaner.
- Created to protect the motor.

REF.



CLEAR VACUUM CLEANER WET FILTER	52947	1
---------------------------------	-------	---





# AS-30 PRO VACUUM CLEANER

## VACUUM ADAPTABLE TO ELECTRIC MACHINES

To vacuum wet or dry.



CATEGORY: PRO

EASY HANDLING

LIGHT

- For wet and dry vacuuming.
- Power: 1400 W.
- Airflow: 58 l / s.
- Vacuum: 180 mbar. (18 psi.)
- Capacity: 30 l.
- Double switch: On / Off and automatic start.
- Socket for electric tool (max.2000W)
- Electrical cable: 4 m.
- Accessories included:
  - Hose, nozzle (35/37 mm) and crevice tool.
  - Steel pipes.
  - Wet brush.
  - Filter damp sponge for wet.
  - HEPA filter for dry.

	REF.				
<b>AS-30 PRO VACUUM CLEANER</b>	50962	210-240V/50-60 Hz	25 1/4x14 x14 * 64x38x38 cm	1	9

### ACCESSORIES



**REF. 50964**  
AS-30 PRO Vacuum  
Cleaner Paper Bag.



**REF. 50998**  
AS-30 PRO Vacuum  
Cleaner Dry Filter



**REF. 50999** AS-30 PRO  
Vacuum Cleaner Wet  
Filter.



**CATEGORY:  
PRO**



### AS-30 PRO VACUUM CLEANER PAPER BAG.

- Paper bag for dust vacuuming.
- Compatible with AS-30 PRO.
- Biodegradable.
- 4 units set.

REF.



AS-30 PRO VACUUM CLEANER PAPER BAG.

50964

1

**CATEGORY:  
PRO**



### AS-30 PRO VACUUM CLEANER DRY FILTER

- HEPA filter for dry vacuuming.
- Compatible with AS-30 PRO.
- Minimum particle size: 5 µm.

REF.



AS-30 PRO VACUUM CLEANER DRY FILTER

50998

1

**CATEGORY:  
PRO**



### AS-30 PRO VACUUM CLEANER WET FILTER.

- Filter for wet vacuuming.
- Compatible with AS-30 PRO.
- 2 units set.

REF.



AS-30 PRO VACUUM CLEANER WET FILTER.

50999

1





# DIAMOND BLADES

---

Dry cutting diamond blades  
Wet cutting diamond blades





# DIAMOND BLADES - DRY CUT

• DIAMOND BLADES WITHOUT NEED OF WATER FOR COOLING.



▲ CATEGORY: SUPERPRO    UNIVERSAL    GENERAL CONSTRUCTION    ALL TERRAIN 4X4

## GENERAL PURPOSE SEGMENTED DIAMOND BLADE (STT)

- Recommended blade for cutting all types of building materials, including reinforced concrete. High performance and speed of cutting.
- For cutting materials > 25 mm thickness.

	REF.					RPM	
STT 115 SUPERPRO	30974	4 1/2" 115 mm	7/8" 22,2 mm	1" 2,2 mm	3/8" 10 mm	13300 max.	5
STT 230 SUPERPRO	30976	9 1/8" 230 mm				6650 max.	



▲ CATEGORY: PRO    UNIVERSAL    GENERAL CONSTRUCTION    HEAVY DUTY    FAST

## GENERAL PURPOSE SEGMENTED DIAMOND BLADE (SEV)

- Recommended for cutting building materials such as brick, concrete, terrazzo.
- The fastest. Maximum speed and best blade's cooling. To cut materials with more than 1" (25 mm) thickness.
- Perforated steel blade to improve cooling and diminish cut's tensions.

	REF.					RPM	
SEV 115 PRO	25915	4 1/2" 115 mm	7/8" 22,2 mm	1" 1,6 mm	3/8" 8 mm	13300 max.	5
SEV 125 PRO	32940	4 7/8" 125 mm				12250 max.	
SEV 230 PRO	25916	9 1/8" 230 mm	7/8" 2,3 mm	1" 2,3 mm	6650 max.	1	



▲ CATEGORY: SUPERPRO    ▲ CATEGORY: PRO    UNIVERSAL CERAMIC    GOOD FINISH

## CERAMIC TILES CONTINUOUS RIM DIAMOND BLADE (CSV)

- Blade for general cut of ceramic tiles as wall tile, floor tiles, porcelain.
- The best finish. To cut ceramic tiles and other stone coating materials with less than 3/4" (20 mm) thickness.

	REF.					RPM	
CSV 115 PRO	25910	4 1/2" 115 mm	7/8" 22,2 mm	1" 1,6 mm	3/8" 8 mm	13300 max.	5
CSV 125 PRO	31915	4 7/8" 125 mm				12250 max.	
CSV 125 SUPERPRO	30883	4 7/8" 125 mm	12250 max.	1			



**CATEGORY: PRO**    **UNIVERSAL**    **GENERAL CONSTRUCTION**    **VERSATILE**

**GENERAL PURPOSE TURBO DIAMOND BLADE (TSV)**

- Recommended for cutting building materials such as bricks, concrete, terrazzo.
- A great combination. High performance and cutting speed with high standard finishes.

	REF.					RPM	
<b>TSV 115 PRO</b>	25917	4 1/2" 115 mm	7/8"	1/8" 2 mm	3/8"	13300 max.	5
<b>TSV 230 PRO</b>	25918	9 1/8" 230 mm	22,2 mm	1/8" 2,5 mm	8 mm	6650 max.	1



**CATEGORY: SUPERPRO**    **HARD MATERIAL**    **MITRE CUT (45°)**    **EXTRA LONG LIFE**

**HARD MATERIALS TURBO VIPER DIAMOND BLADE MITRE & STRAIGHT (TGS)**

- Diamond blade for straight and 45° (mitring) cuts on dry.
- For use with porcelain materials and natural stone.
- A great combination. High performance and cutting speed with high-quality finishes.
- Suitable for use with a grinder.
- It is not recommended to use the TGS blade on circular saws (e.g. TC-125).

	REF.					RPM	
<b>TGS 115 SUPERPRO</b>	40917	4 1/2" 115 mm	7/8"	1/8"	*	13300 max.	5
<b>TGS 125 SUPERPRO</b>	40918	4 7/8" 125 mm	22,2 mm	1,6 mm	25 mm	12250 max.	



**CATEGORY: SUPERPRO**    **HARD MATERIAL**    **HEAVY DUTY**    **FAST**

**HARD MATERIALS TURBO DIAMOND BLADE VIPER (TVR)**

- Recommended blades to cut hard materials such as granite, slate, quartzite, rustic tiles, clinker and porcelain tile.
- Robust blade, ready to support high tensions in the extremes of the blade.
- For cutting materials > 3/4" (20 mm) thickness.
- High cutting speed.
- Reinforced blade.
- Is suitable for mitre cuts.

	REF.					RPM	
<b>TVR 115 SUPERPRO</b>	30986	4 1/2" 115 mm	7/8"	1/8"	3/8"	13300 max.	5
<b>TVR 125 SUPERPRO</b>	30987	4 7/8" 125 mm	22,2 mm	1,4 mm	10 mm	12250 max.	



**CATEGORY: SUPERPRO**    **HARD MATERIAL**    **LONG LIFE**    **FAST**

**HARD MATERIALS SEGMENTED DIAMOND BLADE "CANTERO" (SCA)**

- Recommended for cutting high hardness natural stones such as granite, basalt, quartzite, concrete drive, etc.
- Long life and high performance. Bar of 12 mm.
- High speed cutting.
- For cutting materials > 25 mm thickness.

	REF.					RPM	
<b>SCA 230 SUPERPRO</b>	30904	9 1/8" 230 mm	7/8"	1/8" 3 mm	1/2" 12 mm	6650 max.	1



**CATEGORY: SUPERPRO**   **HARD MATERIAL**   **FAST**   **GOOD FINISH**

### HARD MATERIALS TURBO VIPER DIAMOND BLADE (TVA)

- Recommended blade for cutting hard materials such as granite, rustic tiles, clinker, refractory, slate, quartzite and porcelain tile.
- The specific design of the diamond band offers greater speed of cutting harder materials without sacrificing finish quality.
- Only for straight cuts, not suitable for mitring.

	REF.					RPM	
<b>TVA 115 SUPERPRO</b>	31932	4 1/2" 115 mm	7/8" 22,2 mm	1/8" 1,4 mm	3/8" 10 mm	13300 max.	5
<b>TVA 125 SUPERPRO</b>	31933	4 7/8" 125 mm				11500 max.	
<b>TVA 180 SUPERPRO</b>	31934	7 1/8" 180 mm		8500 max.		3	
<b>TVA 230 SUPERPRO</b>	31935	9 1/8" 230 mm		6650 max.			1



**CATEGORY: SUPERPRO**   **HARD MATERIAL**   **FAST**   **GOOD FINISH**

### HARD MATERIALS TURBO MINI VIPER DIAMOND BLADE (TVA)

- Blade recommended for cutting hard materials such as granite, slate, porcelain stoneware, natural stone and sintered stone, etc.
- Especially for outlet holes.
- Fast cut.
- Long life. Due to the metal alloy of the diamond particle coating, it is resistant to high temperatures which prevents burning of the blade.
- It leaves a very good finish on the tile.
- Only for straight cuts, not suitable for mitre cuts.

	REF.					RPM	
<b>TVA 85 SUPERPRO</b>	32951	3 3/8" 85 mm	7/8" 22,2 mm	1/8" 1,5 mm	3/8" 10 mm	19000 max.	5



**CATEGORY: PRO**   **PORCELANIC**   **QUALITY FINISH**   **FAST**

### PORCELAIN TILES SLITHER PRO

- Recommended for cutting porcelain material, but it can also cut other materials, such as natural stone, granite or marble.
- Especially suitable for fine cuts with good quality.
- J-Slot type fast disk.
- Not suitable for mitre cutting.





	REF.					RPM	
<b>SLITHER 115 PRO</b>	32953	4 1/2" 115 mm	7/8" 22,2 mm	1/8" 1,25 mm	3/4" 6 mm	13300 max.	5
<b>SLITHER 125 PRO</b>	32954	4 7/8" 125 mm				12250 max.	



**CATEGORY: SUPERPRO**    **PORCELANIC**    **EXCELLENT QUALITY FINISH**    **FAST**

### PORCELAIN TILES SLITHER SUPERPRO

- Recommended for cutting porcelain material, but it can also cut other materials, such as natural stone, granite or marble.
- Especially for VERY fine cuts with EXCELLENT quality.
- J-Slot type fast disk.
- Not suitable for mitre cutting.





	REF.					RPM	
<b>SLITHER 115 SUPERPRO</b>	32960	4 1/2" 115 mm	7/8" 22,2 mm	1/8" 1,1 mm	3/8" 8 mm	13300 max.	5
<b>SLITHER 125 SUPERPRO</b>	32961	4 7/8" 125 mm				12250 max.	



**CATEGORY: SUPERPRO**    **PORCELANIC**    **GOOD FINISH**

### PORCELAIN TILES CONTINUOUS RIM DIAMOND BLADE (CPR)

- Recommended blade to cut fine porcelain tiles with less than 3/4" (20 mm) thickness.
- The best finish.





	REF.					RPM	
<b>CPR 115 SUPERPRO</b>	30972	4 1/2" 115 mm	7/8" 22,2 mm	1/8" 1,7 mm	3/8" 8 mm	13300 max.	5
<b>CPR 125 SUPERPRO</b>	30973	4 7/8" 125 mm				12250 max.	



**CATEGORY: SUPERPRO**    **PORCELANIC**    **FAST**

### PORCELAIN TILES TURBO DIAMOND BLADE (TCR)

- Recommended blade to cut fine porcelain tiles.
- High performance and fast cutting speed with high quality finishes.

	REF.					RPM	
<b>TCR 115 SUPERPRO</b>	31972	4 1/2" 115 mm	7/8" 22,2 mm	1/8" 14 mm	3/8" 8 mm	13300 max.	5
<b>TCR 125 SUPERPRO</b>	31973	4 7/8" 125 mm		1/8" 1,6 mm		12250 max.	
<b>TCR 180 SUPERPRO</b>	31975	7 1/8" 180 mm		1/8" 1,6 mm	8500 max.	3	
<b>TCR 230 SUPERPRO</b>	31978	9 1/8" 230 mm		1/8" 2 mm			6650 max.



**CATEGORY: SUPERPRO**   **PORCELANIC**   **EXTRA LONG LIFE**   **FAST**   **LANDSCAPING**

**PORCELAIN TILES DIAMOND BLADE 2CM (TLG)**

- Specially designed for landscaping materials.
- Ideal for dry cutting porcelain, ceramic, natural stone and sintered stone materials of > 20 mm with a grinder.
- A great combination. High performance and cutting speed with high-quality finishes.
- Not suitable for dry cutting with the TC-125 or circular saw.

	REF.					RPM	
<b>TLG 115 EXT SUPERPRO</b>	41900	4 1/2" 115 mm	7/8"	1/8"	3/8"	13300 max.	5
<b>TLG 125 EXT SUPERPRO</b>	41901	4 7/8" 125 mm	22,2 mm	1,4 mm	10 mm	12250 max.	





<b>CATEGORY: SUPERPRO</b>	<b>PORCELANIC</b>	<b>FAST</b>	<b>GOOD FINISH</b>
---------------------------	-------------------	-------------	--------------------

**PORCELAIN TILES J-SLOT DIAMOND BLADE (CPJ)**

- For cutting hard porcelain tiles with the best performance.
- Specially recommended for straight cuts and high speed cutting.
- Thanks to J-Slot typology, this disc increases cutting speed on very hard porcelain tiles, while reducing the stresses generated throughout out the cut.
- It's original design is for dry cutting, but also allows wet cutting.

	REF.					RPM	
<b>CPJ 115 SUPERPRO</b>	32932	4 1/2" 115 mm	7/8"	1/8"	3/8"	13300 max.	5
<b>CPJ 125 SUPERPRO</b>	32933	4 7/8" 125 mm	22,2 mm	1,4 mm	8 mm	12250 max.	



<b>CATEGORY: SUPERPRO</b>	<b>MARBLE</b>	<b>FAST</b>
---------------------------	---------------	-------------

**MARBLE ELECTROPLATED DIAMOND BLADE (EMG)**

- Recommended electroplated diamond blade to cut marble, limestone and fibres.
- Less vibration. To cut those materials with high risk of breaking, as marble and fibres.

	REF.					RPM	
<b>EMG 115 SUPERPRO</b>	30995	4 1/2" 115 mm	7/8"	1/8"	1/8"	13300 max.	5



<b>CATEGORY: SUPERPRO</b>	<b>METAL, PLASTIC, WOOD</b>	<b>FAST</b>
---------------------------	-----------------------------	-------------

**DIAMOND BLADE RESCUE (RSQ)**

- Recommended disc for cutting all types of materials including metal, plastic and wood, and more.
- Vacuum Brazed Technology.
- Increased resistance to high temperatures during cutting, reduction of spark generated.
- High speed and performance.

	REF.					RPM	
<b>RSQ 115 SUPERPRO</b>	30900	4 1/2" 115 mm	7/8"	1/8"	1/8"	13300 max.	5
<b>RSQ 230 SUPERPRO</b>	30902	9 1/8" 230 mm	22,2 mm	1/8"	4 mm	6650 max.	1



<b>CATEGORY: SUPERPRO</b>	<b>NO VIBRATIONS</b>	<b>GOOD FINISH</b>
---------------------------	----------------------	--------------------

**CUTTING & GRINDING BLADES**

- For cutting and grinding soft natural stone and ceramic tiles and synthetic materials.
- For adjustment cuts and grinding on all types of porcelain and hard materials.
- Electroplated continuous rim blade.
- Two-sided and reversible blade for a better performance.
- For grinders use. Connection: M14 thread.

	REF.					RPM	
<b>ECD 115 2IN1 SUPERPRO</b>	31964	4 1/2" 115 mm	M14"	1/8"	1/4"	13300 max.	1
<b>ECD 125 2IN1 SUPERPRO</b>	31965	4 7/8" 125 mm	M14 mm	1,8 mm	5,6 mm	12250 max.	

## ACCESSORIES DIAMOND BLADES - DRY CUT

2  
Cut & Drill

NEW!



CATEGORY: SUPERPRO

•• USE: PROFESSIONAL

## CUT MASTER GUIDE

- To increase the stability and comfort when cutting. Improves the quality of the cut and the performance of the blade.
- The connection to vacuum cleaner completely removes dust from the cutting zone. Silicone seal does not allow dust leaks.
- Fits all models of an angle grinder Ø115, Ø125 mm. It is not needed to remove original blade protector.
- Wheels holds the weight of the angle grinder when cutting. It is much easier to guide the blade in a straight line.
- Vacuum cleaner connector Ø35 mm.
- Rubber wheels of Ø30 mm that not marks the tile.



	REF.	
CUT MASTER GUIDE 90°	40922	1

# DIAMOND BLADES - WET CUT





• DIAMOND BLADES COOLED WITH WATER.



 **CATEGORY: SUPERPRO**
 **CATEGORY: PRO**
**UNIVERSAL**
**GENERAL CONSTRUCTION**
**FAST**

## GENERAL PURPOSE SEGMENTED DIAMOND BLADE (SHR)

- Recommended for cutting building materials such as brick, concrete, terrazzo.
- The fastest. Maximum speed and best blade's cooling. To cut materials with more than 1" (25 mm) thickness.

	REF.					RPM	
<b>SHR 250 PRO</b>	32974	9 7/8" 250 mm	1 1/8" 25,4 mm	1/8" 2,6 mm	3/8" 10 mm	6150 max.	1
<b>SHR 350 SUPERPRO</b>	32971	13 3/4" 350 mm		1/8" 3 mm		4400 max.	



 **CATEGORY: SUPERPRO**
 **CATEGORY: PRO**
**UNIVERSAL CERAMIC**
**GOOD FINISH**

## CERAMIC TILES CONTINUOUS RIM DIAMOND BLADE (CEV)

- Blade for general cut of ceramic tiles as wall tile, floor tiles, porcelain.
- The best finish. To cut and mitre ceramic tiles and other stone coating materials with less than 3/4" (20 mm) thickness.





	REF.					RPM	
<b>CEV 180 PRO</b>	25912	7 1/8" 180 mm	7/8-1 1/8" 22,2 - 25,4 mm	1/8"	3/8" 8 mm	8500 max.	3
<b>CEV 200 PRO</b>	25913	7 7/8" 200 mm	1 1/8"	1,7 mm		7650 max.	1
<b>CEV 250 PRO</b>	25934	9 7/8" 250 mm	25,4 mm	1/8" 2,2 mm	8500 max.	3	
<b>CEV 180 SUPERPRO</b>	30945	7 1/8" 180 mm	7/8-1 1/8" 22,2 - 25,4 mm	1/8"	3/8" 8 mm	8500 max.	3
<b>CEV 200 SUPERPRO</b>	30946	7 7/8" 200 mm	1 1/8"	1,7 mm		7650 max.	
<b>CEV 250 SUPERPRO</b>	30949	9 7/8" 250 mm	1 1/8" 25,4 mm	1/8"	8500 max.	3	1
<b>CEV 300 SUPERPRO</b>	30950	11 3/4" 300 mm		2,2 mm	3/8" 10 mm	5100 max.	



 **CATEGORY: SUPERPRO**
**HARD MATERIAL**
**GOOD FINISH**

## HARD MATERIALS CONTINUOUS RIM DIAMOND BLADE (CPA)

- Recommended for cutting hard materials such granite, rustic tiles, clinker, firebricks or slate.
- The best finish. To cut and mitre ceramic tiles and other stone coating materials.

	REF.					RPM	
<b>CPA 180 SUPERPRO</b>	30925	7 1/8" 180 mm	7/8" 22,2 mm	1/8"	3/8" 8 mm	8500 max.	3
<b>CPA 200 SUPERPRO</b>	30926	7 7/8" 200 mm		1,7 mm		7650 max.	
<b>CPA 250 SUPERPRO</b>	30929	9 7/8" 250 mm	1 1/8" 25,4 mm	1/8"	3/8" 8 mm	6150 max.	1
<b>CPA 300 SUPERPRO</b>	30930	11 3/4" 300 mm		2,2 mm		5100 max.	
<b>CPA 350 SUPERPRO</b>	30931	13 3/4" 350 mm		1/8" 2,6 mm	10 mm	4400 max.	



**CATEGORY: SUPERPRO**    **HARD MATERIAL**    **FAST**    **GOOD FINISH**

**HARD MATERIALS TURBO VIPER DIAMOND BLADE (TVH)**

- Recommended blade for cutting hard materials such as granite, rustic tiles, clinker, refractory, slate, quartzite and porcelain tile.
- The specific design of the diamond band offers greater speed of cutting harder materials without sacrificing finish quality.
- For cutting materials > 3/4" (20 mm) thickness.
- Only for straight cuts, not suitable for mitring.

	REF.					RPM	
<b>TVH 200 SUPERPRO</b>	31936	7 7/8" 200 mm	1 1/8" 25,4 mm	1/8" 16 mm	3/8" 10 mm	7650 max.	1
<b>TVH 250 SUPERPRO</b>	31937	9 7/8" 250 mm				6150 max.	
<b>TVH 300 SUPERPRO</b>	31938	11 3/4" 300 mm		5100 max.			
<b>TVH 350 SUPERPRO</b>	31939	13 3/4" 350 mm		4400 max.			



**CATEGORY: PRO**    **PORCELANIC**    **GOOD FINISH**

**PORCELAIN TILES CONTINUOUS RIM DIAMOND BLADE (CPC)**

- Recommended blade to cut fine porcelain tiles with less than 3/4" (20 mm).
- Specially recommended for mitre cutting.

	REF.					RPM	
<b>CPC 180 PRO</b>	30955	7 1/8" 180 mm	7/8-1 1/8" 22,2 - 25,4 mm	1/8" 1,7 mm	3/8" 8 mm	8500 max.	3
<b>CPC 200 PRO</b>	30956	7 7/8" 200 mm	1 1/8" 25,4 mm			7650 max.	
<b>CPC 230 PRO</b>	30958	9 1/8" 230 mm	7/8-1 1/8" 22,2 - 25,4 mm	1/8" 2 mm	3/8" 10 mm	6650 max.	1
<b>CPC 250 PRO</b>	30959	9 7/8" 250 mm	1 1/8"	1/8" 2,2 mm		6150 max.	
<b>CPC 300 PRO</b>	30960	11 3/4" 300 mm	25,4 mm	5100 max.			



**CATEGORY: PRO**    **PORCELANIC**    **FAST**    **GOOD FINISH**

**PORCELAIN TILES J-SLOT DIAMOND BLADE (CPX)**

- Recommended disc to cut fine porcelain tiles.
- High Tech. High speed on straight cuts on porcelain tiles >20 mm.





	REF.					RPM	
<b>CPX 200 PRO</b>	30964	7 7/8" 200 mm	1 1/8" 25,4 mm	1/8" 1,6 mm	3/8" 8 mm	7650 max.	1
<b>CPX 250 PRO</b>	30962	9 7/8" 250 mm				6150 max.	
<b>CPX 300 PRO</b>	30963	11 3/4" 300 mm				5100 max.	

**CATEGORY: SUPERPRO**
**PORCELANIC**

**MITRE CUT (45°)**

### DIAMOND PORCELAIN STONEWARE TURBO MITRE (TPI)





- For the mitre cut of porcelain tiles. High stability and speed of cut.
- Sintered TURBO blade.
- Laser welding.

	REF.					RPM	
<b>TPI 200 SUPERPRO</b>	31966	7 7/8" 200 mm	1 1/8" 25,4 mm	1/8" 2,5 mm	3/8" 8 mm	7650 max.	1
<b>TPI 230 SUPERPRO</b>	31967	9 1/8" 230 mm				6650 max.	
<b>TPI 250 SUPERPRO</b>	31969	9 7/8" 250 mm				6150 max.	

**CATEGORY: PRO**
**PORCELANIC**
**LANDSCAPING**
**LONG LIFE**
**FAST**

### PORCELAIN TILES DIAMOND BLADE 2CM PRO (TPL)

- Specially designed for landscaping materials.
- Ideal for cutting porcelain, ceramic, natural stone and sintered stone materials of > 20 mm.
- A great combination of high performance and cutting speed with high-quality finishes.
- With holes in the core to help cool the disc and distribute water evenly across the disc.

	REF.					RPM	
<b>TPL 250 EXT PRO</b>	40913	9 7/8" 250 mm	1 1/8" 25,4 mm	1/8" 1,4 mm	3/8" 8,5 mm	6150 max.	1
<b>TPL 300 EXT PRO</b>	40914	11 3/4" 300 mm				5100 max.	

**CATEGORY: SUPERPRO**
**PORCELANIC**
**LANDSCAPING**
**LONG LIFE**
**VERY FAST**

### PORCELAIN TILES DIAMOND BLADE 2CM SUPERPRO (SPL)

- Specially designed for landscaping materials.
- Ideal for cutting porcelain, ceramic, natural stone and sintered stone materials of > 20 mm.
- Segmented.
- Due to the diamond rim's special alloy, these types of materials can be cut quickly and have an extra-long life.
- Good finish.

	REF.					RPM	
<b>SPL 250 EXT SUPERPRO</b>	40910	9 7/8" 250 mm	1 1/8" 25,4 mm	1/8" 1,6 mm	3/8" 10 mm	6150 max.	1



**◇ CATEGORY: PREMIUM    PORCELANIC    LANDSCAPING    EXTRA LONG LIFE    VERY FAST**

### **PORCELAIN TILES PREMIUM 2CM DIAMOND BLADE (SPT)**

- For cutting all types of ceramic, porcelain and natural stone materials.
- For cutting thicknesses from 20 mm to 35 mm.
- Joint by laser welding.
- Extra-long life.
- Suitable for use on cutting tables and cut-off machines that incorporate guard systems in compliance with the standard for use of segmented blades.
- Special bonded alloy that provides a good finish with a very fast cutting speed.

	REF.	⊙	⊙	⊙	⊙	RPM	⊞
<b>SPT 250 EXT PREMIUM</b>	32934	9 7/8" 250 mm	1 1/8" 25,4 mm	1/8" 2,2 mm	3/8" 10 mm	6150 max.	1
<b>SPT 300 EXT PREMIUM</b>	32935	11 3/4" 300 mm		1/8" 2,4 mm		5100 max.	
<b>SPT 350 EXT PREMIUM</b>	32936	13 3/4" 350 mm	4400 max.				



**CATEGORY: SUPERPRO**      **ABRASIVE**      **LONG LIFE**

**ABRASIVE MATERIALS TURBO DIAMOND BLADE (TON)**

- Recommended blades to cut abrasive materials such as bricks, calcareous terrazzo, marble, sandstone.
- A great combination. High performance and cutting speed with high standard finishes.

	REF.					RPM	
<b>TON 250 SUPERPRO</b>	31909	9 7/8" 250 mm	1 1/8" 25,4 mm	1/8" 2,5 mm	1/4" 7,5 mm	6150 max.	1



**GENERAL PURPOSE**

Recommended blade for cutting concrete and hard materials such as granite, slate, refractory, brick, etc.



**GENERAL PURPOSE**

Recommended blade for general cutting of building materials such as brick, concrete, terrazzo, natural stone, etc.



**GENERAL CERAMIC MATERIAL**

Recommended blades for cutting marble, fibres and other materials with high breakage risk.



**HARD MATERIALS**

Recommended blade for cutting hard materials such as granite, slate, firebrick, etc.



**PORCELAIN**

Recommended blades for fine cuts of porcelain tiles.



**ABRASIVES**

Recommended blades for cutting abrasive materials such as bricks, calcareous terrazzo, marble, sandstone, etc.



**MARBLE**

Recommended blade for cutting marble, limestone and fibres.



**RESCUE**

Recommended blade for cutting all kinds of materials such as steel sheet, wood, masonry materials, fiberglass, PVC, steel rods, concrete, reinforced concrete, etc ...

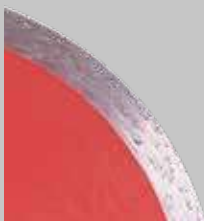

**CONTINUOUS RIM**

The best finish. For cutting and mitring ceramic tiles and other stone coating materials <1" (25mm) thickness.



**TURBO**

A great combination. High performance and speed of cut with high quality finishings.



**SEGMENTED**

The Fastest. Maximum speed and best blade's cooling. To cut materials >1" (25mm) thickness.



**VACUUM BRAZED**

The most versatile. Due to his versatility in not petrous materials and cutting speed.



**ELECTROPLATED**

Less vibration. To cut those materials with high risk of breaking as marble or fibres.



**J-SLOT**

High-Tech. High speed on hardest materials. Specially designed for straight cuts on porcelain tiles.

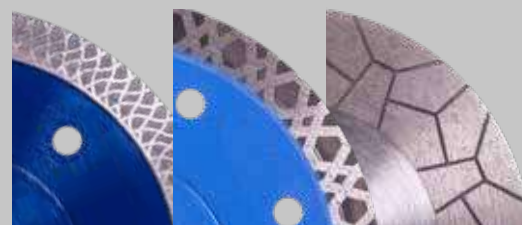

**VIPER**

Best of a TURBO, with the best finishes and cutting speed.



	CONTINUOUS RIM		J-SLOT	TURBO				VIPER				SEGMENTED				ELECTROPLATED		VACUUM BRAZED	
	CSV	CPR	CPJ	TSV	TSA	TCR	TLG	TVR	TVA	MINI TVA	TGS	STT	SEV	SHA	SCA	SON	EMG	ECD	RSQ
CERAMIC TILES	○																		
FIBRE										○							○	○	
GLASS																		○	
GRANITE	○			○	○		○	○	○	○	○	○	○	○	○				
HARD STONE	○			○	○			○	○	○			○	○					
LANDSCAPING							○	○	○	○									
MARBLE	○			○						○	○			○	○	○			
PORCELAIN TILES	○	○	○			○	○	○	○	○								○	
ABRASIVE MATERIAL				○							○	○			○				○
SLATE				○	○		○	○	○	○	○	○	○	○	○			○	○
CONCRETE				○							○	○			○				
PLASTIC																			○
WOOD																			○
METAL																			○

Optimal Use ○  
Alternative Use ○





	CONTINUOUS RIM			J-SLOT	TURBO			VIPER	SEGMENTED		
	CEV	CPA	CPC	CPX	TON	TPI	TPL	TVH	SPL	SHR	SPT
CERAMIC TILES	○										
FIBRE					○					○	
GLASS			○								
GRANITE	○	○					○	○	○	○	○
HARD STONE		○						○			
LANDSCAPING							○		○		○
MARBLE	○				○					○	
PORCELAIN TILES	○	○	○	○		○	○	○	○		○
ABRASIVE MATERIAL					○					○	
SLATE		○						○	○	○	○
CONCRETE					○					○	
PLASTIC											○
WOOD											○
METAL											○

Optimal Use ○  
Alternative Use ○





# DRILLING

---

Tools for drilling ceramic tile, stoneware, marble, granite and other materials.



# TUNGSTEN CARBIDE DRILL BITS

- TUNGSTEN CARBIDE BITS FOR DRILLING WALL TILES.
- ADAPTABLE TO MANUAL DRILL AND HEAD FOR ELECTRIC DRILL WITHOUT HAMMER.



**CATEGORY: PRO**    **MATERIAL: CERAMIC TILE**    **ELECTRIC DRILL WITHOUT PERCUSSION**

## TUNGSTEN CARBIDE DRILL BITS

- Tungsten carbide drill bits for wall tiles. Adaptable to head for use with electric drill without hammer (ref. 04992).

	REF.	RPM			
DRILL BIT 1 3/8" [35 MM.]	04962	800 max.	3/4" 18 mm	5	780
DRILL BIT 1 3/4" [45 MM.]	04964				
DRILL BIT 2 1/4" [55 MM.]	04965				

**CATEGORY: PRO**



## HEAD AND CENTRAL ATTACHMENT DRILL BIT

- Attachable to all measures of Tungsten Carbide drill bits.
- Supplied in blister.

	REF.	
HEAD WITH CENTRAL ATTACHMENT DRILL BIT	04992	1



# DIAMOND DRILL BITS - DRY CUT

• FOR DRY DRILLING OF WALL TILES, FLOOR TILES AND PORCELAIN TILES.



CATEGORY: SUPERPRO

MATERIAL: PORCELAIN TILE

GRINDER

ELECTRIC DRILL  
WITHOUT PERCUSSION

## DRYGRES DRILL BITS

- For dry drilling in ceramic, porcelain, natural stone and other materials.
- Maximum operating speed 14,000 r.p.m. M14 thread finish. Usable with grinder. Supplied in blister.

	REF.	RPM		
DRYGRES DRILL BIT Ø 1/4" [6 MM.]	05988	14000 max.		
DRYGRES DRILL BIT Ø 2/7" [7 MM.]	05994			
DRYGRES DRILL BIT Ø 5/16" [8 MM.]	05989			
DRYGRES DRILL BIT Ø 3/8" [10 MM.]	05990			
DRYGRES DRILL BIT Ø 1/2" [12 MM.]	05991			
DRYGRES DRILL BIT Ø 3/4" [20 MM.]	04910			
DRYGRES DRILL BIT Ø 1" [25 MM.]	57903	14000	13/8" 36 mm	1
DRYGRES DRILL BIT Ø 1 1/8" [28 MM.]	04911	14000 max.		
DRYGRES DRILL BIT Ø 1 3/8" [35 MM.]	04912			
DRYGRES DRILL BIT Ø 1 3/4" [43 MM.]	04913			
DRYGRES DRILL BIT Ø 2" [50 MM.]	04914			
DRYGRES DRILL BIT Ø 2 3/8" [60 MM.]	04915			
DRYGRES DRILL BIT Ø 2 1/2" [65 MM.]	04916			
DRYGRES DRILL BIT Ø 2 11/16" [68 MM.]	04917	14000		
DRYGRES DRILL BIT Ø 3" [75 MM.]	05992			
DRYGRES DRILL BIT Ø 3 1/8" [80 MM.]	57904			
DRYGRES DRILL BIT Ø 3 1/4" [85 MM.]	57906			
DRYGRES DRILL BIT Ø 4" [100 MM.]	57907			
DRYGRES DRILL BIT Ø 4 3/4" [120 MM.]	57908			



**CATEGORY: SUPERPRO** **MATERIAL: PORCELAIN TILE** **GRINDER** **ELECTRIC DRILL WITHOUT PERCUSSION**

**KIT DRYGRES**

- They can be used both with grinders or drill without hammer, using the included adapter kit.
- The kit includes: MULTIDRILL guide with carry case. Ref.50917, Ref.50936, Ref.50996.
- Dry cutting diamond drill bits:
- Ø1 1/8"(28mm),1 3/8"(35mm),1 3/4"(43mm)& 2 11/16"(68mm).
- Ø1 1/8"(28mm),1 3/8"(35mm),1 3/4"(43mm),2"(50mm)&2 11/16"(68mm).
- Ø1/4"(6mm),5/16"(8mm),3/4"(20mm),1 3/8"(35mm),50 & 2 11/16"(68mm).

	REF.	RPM		
<b>KIT 4 BITS DRYGRES</b>	50917	14000 max.	1 3/8" 36 mm	1
<b>KIT 5 BITS DRYGRES</b>	50936			
<b>KIT 6 BITS DRYGRES</b>	50996			



**CATEGORY: SUPERPRO** **MATERIAL: PORCELAIN TILE** **GRINDER** **ELECTRIC DRILL WITHOUT PERCUSSION**

**KIT MINI DRYGRES**

- Dry cutting diamond drill bits for drilling porcelain tiles, glazed tiles, natural stone and other ceramics.
- They can be used both with grinders or drill without hammer, using the included adapter kit.
- Kit includes:
- Drill Ø 1/4"(6 mm), 5/16"(8 mm), 3/8"(10 mm) and 1/2"(12 mm).
- Case.

	REF.	RPM		
<b>KIT MINI DRYGRES</b>	50938	14000 max.	1 3/8" 36 mm	1



**CATEGORY: SUPERPRO** **MATERIAL: PORCELAIN TILE** **GRINDER** **ELECTRIC DRILL WITHOUT PERCUSSION**

**KIT TCR BLADE AND DRYGRES DRILL BITS**

- They can be used both with grinders or drill without hammer, using the included adapter kit.
- Kit includes:
- Dry diamond cutting disc TCR-115.
- Four dry cutting diamond drill bits (2x6mm, 20mm, 35mm)(2x1/4", 13/16", 1 3/8").

	REF.	
<b>KIT TCR BLADE AND DRYGRES DRILL BITS</b>	68925	1

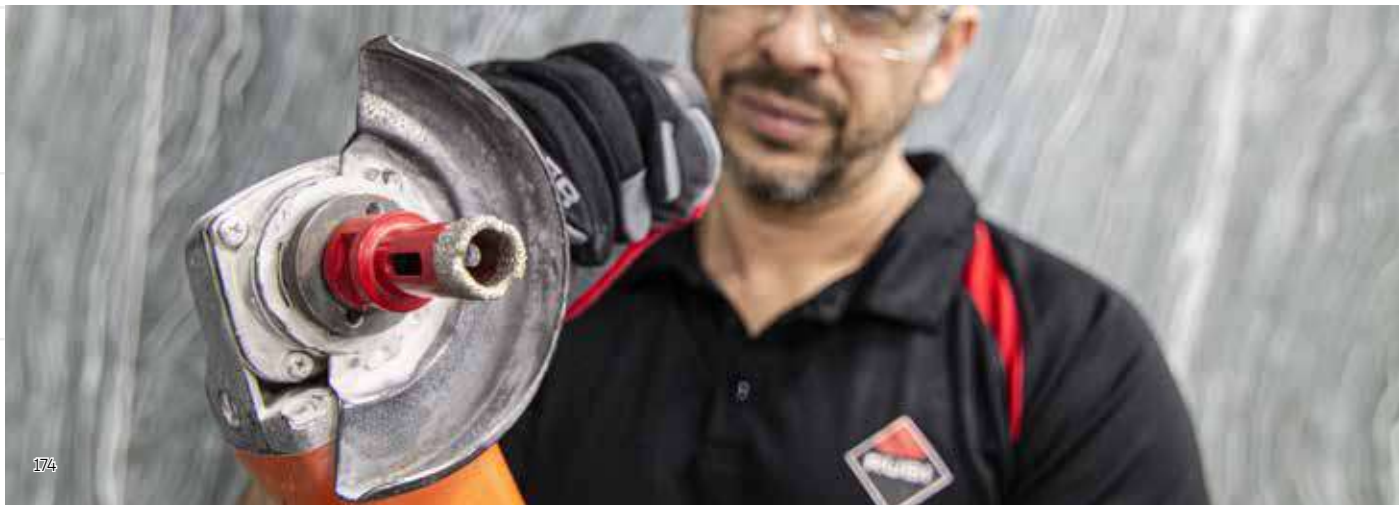





 CATEGORY: PREMIUM	 MATERIAL: PORCELAIN TILE	 EXTRA LONG LIFE	 GRINDER	 ELECTRIC DRILL WITHOUT PERCUSSION
---	--	--	---	---

### DRYGRES PREMIUM DRILL BITS

- Designed for the fast drill of any kind of ceramic tiles including porcelain, but also suitable to drill natural stone as granite or marble, and sintered stone.
- Vacuum brazed type drill bits that provides a very fast dry drilling with very good quality.
- Resistant brazed of diamond grits and great quality materials for extra long life.
- Integrated wax only in the smallest diameters (6 – 12 mm) to help cooling and lubrication during drilling.
- Side openings for better cooling due to greater air circulation in biggest diameters (20 – 85 mm).
- Air cooled through the own rotation but also recommended to use small orbital movements with the tool to help cooling.
- They can be used both with grinders or drill without hammer, using the included adapter kit.

	REF.	RPM		
DRYGRES PREMIUM DRILL BITS Ø 6 MM.	06900	14000	11/8" 30 mm	1
DRYGRES PREMIUM DRILL BITS Ø 7 MM.	06915			
DRYGRES PREMIUM DRILL BITS Ø 8 MM.	06918			
DRYGRES PREMIUM DRILL BITS Ø 10 MM.	06919			
DRYGRES PREMIUM DRILL BITS Ø 12 MM.	06929			
DRYGRES PREMIUM DRILL BITS Ø 20 MM.	06971			
DRYGRES PREMIUM DRILL BITS Ø 28 MM.	06972		11/2" 38 mm	
DRYGRES PREMIUM DRILL BITS Ø 35 MM.	06973			
DRYGRES PREMIUM DRILL BITS Ø 43 MM.	06974			
DRYGRES PREMIUM DRILL BITS Ø 50 MM.	06975			
DRYGRES PREMIUM DRILL BITS Ø 60 MM.	06976			
DRYGRES PREMIUM DRILL BITS Ø 65 MM.	06977			
DRYGRES PREMIUM DRILL BITS Ø 68 MM.	06978			
DRYGRES PREMIUM DRILL BITS Ø 75 MM.	06979			
DRYGRES PREMIUM DRILL BITS Ø 85 MM.	06980			



 CATEGORY: PREMIUM	 MATERIAL: PORCELAIN TILE	 EXTRA LONG LIFE	 GRINDER	 ELECTRIC DRILL WITHOUT PERCUSSION
---	--	--	---	---

### KIT DRYGRES PREMIUM

- They can be used both with grinders or drill without hammer, using the included adapter kit.
- The kit includes: MULTIDRILL guide with carry case. Ref.51931, Ref.51937, Ref.51929
- Dry cutting diamond drill bits:
  - Ø1 1/8"(28mm), 1 3/8"(35mm), 1 3/4"(43mm) & 2 11/16"(68mm).
  - Ø1 1/8"(28mm), 1 3/8"(35mm), 1 3/4"(43mm), 2"(50mm) & 2 11/16"(68mm).
  - Ø1/4"(6mm), 5/16"(8mm), 3/4"(20mm), 1 3/8"(35mm), 50 & 2 11/16"(68mm).

	REF.	RPM	
KIT 4 DRILL BITS DRYGRES PREMIUM	51931	14000	1
KIT 5 DRILL BITS DRYGRES PREMIUM	51937		
KIT 6 DRILL BITS DRYGRES PREMIUM	51929		



**CATEGORY: PREMIUM** **MATERIAL: PORCELAIN TILE** **EXTRA LONG LIFE** **GRINDER** **ELECTRIC DRILL WITHOUT PERCUSSION**

### KIT MINI DRYGRES PREMIUM

- Dry cutting diamond drill bits for drilling porcelain tiles, glazed tiles, natural stone and other ceramics.
- They can be used both with grinders or drill without hammer, using the included adapter kit.
- Kit includes:
  - Drill Ø 1/4"(6 mm), 5/16"(8 mm), 3/8"(10 mm) and 1/2"(12 mm).
  - Case.

	REF.	RPM	
<b>KIT MINI DRYGRES PREMIUM</b>	51939	14000	1



**CATEGORY: SUPERPRO** **MATERIAL: PORCELAIN TILE** **LONG LIFE** **CORDLESS POWER DRILL**

### DRYGRES DRILL BITS 4DRILL

- Specially designed for dry drilling in porcelain stoneware. Suitable for other ceramic materials, natural stone and artificial stone.
- With high resistant welding of the diamond grains for a longer duration.
- "Easy-Start" Without slipping. Suitable for work without a centring guide.
- Perfect for cordless drills (1000 - 2500 rpm).
- Reinforced body with grub screw for better performance and rigidity, thus maintaining the wax on the tip of the drill (no wax Ø28 & Ø35 mm models).
- High quality finish.
- Designed to be used exclusively with either a cordless drill or an electric drill.
- Their hexagonal connection allows them to adapt quickly to drills with a 10 mm chuck.

	REF.	RPM		
<b>DRYGRES DRILL BITS 4DRILL Ø 1/4" [6 MM.]</b>	05923	1000 min.	17/16" 36 mm	1
<b>DRYGRES DRILL BITS 4DRILL Ø 5/16" [8 MM.]</b>	05924			
<b>DRYGRES DRILL BITS 4DRILL Ø 3/8" [10 MM.]</b>	05926			
<b>DRYGRES DRILL BITS 4DRILL Ø 1/2" [12 MM.]</b>	05927			
<b>DRYGRES DRILL BITS 4DRILL Ø 9/16" [14 MM.]</b>	05928	2000 min.	17/16" 40 mm	
<b>DRYGRES DRILL BITS 4DRILL Ø 3/4" [20 MM.]</b>	05929			
<b>DRYGRES DRILL BITS 4DRILL Ø 1 1/8" [28 MM.]</b>	05970			
<b>DRYGRES DRILL BITS 4DRILL Ø 1 3/8" [35 MM.]</b>	05971			



**CATEGORY: SUPERPRO** **MATERIAL: PORCELAIN TILE** **LONG LIFE** **CORDLESS POWER DRILL**

### KIT DRYGRES 4DRILL

- For dry drilling in porcelain stoneware. Suitable for other ceramic materials, natural stone and artificial stone.
- Hexagonal connection, compatible with battery drills.
- Kit composed of:
  - DRYGRES 4DRILL diamond drills dry cut Ø 6, 8, 10 and 12 mm.
  - With case.

	REF.	RPM	
<b>KIT DRYGRES 4DRILL</b>	05939	1000 min.	1





▶ CATEGORY: SUPERPRO
■ MATERIAL: PORCELAIN TILE
▶ LONG LIFE
▶ GOOD FINISH
▶ LANDSCAPING

### DIAMOND GRINDING BITS

- Suitable for working with natural stone and porcelain.
- To enlarge or modify the diameter and shape of a previously made hole.
- Can also be used for smoothing, polishing or cleaning the interior edges of these holes.
- For dry use with M14 thread grinders.
- High diamond quality and concentration for a long useful life.
- Diamond fixed by means of a vacuum brazing process.
- Provides a good finish thanks to its #50-60 grit size.
- Stable performance with minimum deviation.
- The diamond grinding bits ARE NOT SUITABLE for making holes.

	REF.	RPM			
<b>CYLINDRICAL BIT Ø 20 MM</b>	06985	1100 max.	1" 50 mm	0.33069 lb 0,15 kg	1
<b>CYLINDRICAL BIT Ø 10 MM</b>	06984			0.22046 lb 0,10 kg	
<b>CONICAL BIT Ø 2-35 MM</b>	06986			0.264552 lb 0,12 kg	
<b>CONICAL BIT Ø 20-48 MM</b>	06987			0.573196 lb 0,26 kg	

## DIAMOND DRILL BITS - WET CUT

• FOR WET DRILLING OF WALL TILES, FLOOR TILES, PORCELAIN AND OTHER MATERIALS.



▶ CATEGORY: SUPERPRO
■ MATERIAL: PORCELAIN TILE
▶ EXTRA LONG LIFE
▶ ELECTRIC DRILL WITHOUT PERCUSSION

### FORAGRES DRILL BITS Ø 13/16" TO 4 3/4" (20 - 120 MM.)

- To drill floor tiles, porcelain tiles, granite and marble.
- Always use cooled with water and non-hammer electric drill.
- Ø 1 5/8" (40 mm.) drill bit, designed for housing of toilet flushing mechanisms. Supplied in blister.



	REF.	RPM		
<b>FORAGRES DRILL BIT 3/4" [20 MM.]</b>	04970	900 max.	1 1/8" 30 mm	1
<b>FORAGRES DRILL BIT 1 1/8" [28 MM.]</b>	04971			
<b>FORAGRES DRILL BIT 1 3/8" [35 MM.]</b>	04972			
<b>FORAGRES DRILL BIT 1 5/8" [40 MM.]</b>	04963			
<b>FORAGRES DRILL BIT 2" [50 MM.]</b>	04973			
<b>FORAGRES DRILL BIT 2 1/2" [65 MM.]</b>	04974			
<b>FORAGRES DRILL BIT 2 11/16" [68 MM.]</b>	04918			
<b>FORAGRES DRILL BIT 3" [75 MM.]</b>	04975	450 max.	1 1/4" 33 mm	1
<b>FORAGRES DRILL BIT 4" [100 MM.]</b>	04976		1 1/8" 30 mm	
<b>FORAGRES DRILL BIT 4 3/4" [120 MM.]</b>	04977		1 1/8" 30 mm	



**CATEGORY: SUPERPRO** **MATERIAL: PORCELAIN TILE** **EXTRA LONG LIFE** **ELECTRIC DRILL WITHOUT PERCUSSION**

### KIT FORAGRES

- Kit includes:
- MULTIDRILL Guide.
- Tank and hose.
- Diamond drill bits Ø 3/4", 1 1/8", 1 3/8", 1 3/4", 2" and 2 11/16" (Ø 20, 28, 35, 43, 50, 68 mm). Case.

	REF.	RPM		
KIT FORAGRES	50903	900 max.	1 1/8" 30 mm	1



**CATEGORY: PRO** **MATERIAL: PORCELAIN TILE** **ELECTRIC DRILL WITHOUT PERCUSSION**



### EASY GRES DRILL BITS

- Diamond drill bits to be used with electric drill without hammer.
- The quality of the diamond allows the drilling of ceramics, porcelain, granite, marble and glass.
- Ideal to install bathroom accessories and any type of decorative accessories over ceramic surfaces.
- They must always be used with the EASY GRES guide which allows their adequate cooling ensuring a high accuracy and good results.
- Body made of steel and bit made of electrodeposited diamond.
- Lateral opening to improve cooling of the drill bit and to allow the elimination of solid waste produced after the drilling of the hole.
- Recommended speed of use between 400 and 1000 r.p.m. depending of the material to be drilled.
- To achieve a better finish and a longer life of the drill bit, it's important to observe the adequate speed of use and to apply a moderate pressure during the drilling.
- Supplied in blister.

	REF.	RPM			
EASY GRES DRILL BIT 7/32" [6 MM.]	04922	1000 max.	1" 25 mm	10	4600
EASY GRES DRILL BIT 1/4" [6.5 MM.]	04920				
EASY GRES DRILL BIT 5/16" [8 MM.]	04923				
EASY GRES DRILL BIT 3/8" [10 MM.]	04924				
EASY GRES DRILL BIT 1/2" [12 MM.]	04921				
EASY GRES DRILL BIT 3/4" [20 MM.]	05961	500 max.	1 1/8" 27 mm	1	
EASY GRES DRILL BIT 1 1/8" [28 MM.]	05962				
EASY GRES DRILL BIT 1 3/8" [35 MM.]	05963				
EASY GRES DRILL BIT 1 5/8" [40 MM.]	05964				
EASY GRES DRILL BIT 1 3/4" [43 MM.]	05965				
EASY GRES DRILL BIT 2" [50 MM.]	05966				
EASY GRES DRILL BIT 2 1/4" [55 MM.]	05967				
EASY GRES DRILL BIT 2 1/2" [65 MM.]	05969				
EASY GRES DRILL BIT 2 11/16" [68 MM.]	05978				
EASY GRES DRILL BIT 3" [75 MM.]	05979				
EASY GRES DRILL BIT 4" [100 MM.]	05981				
EASY GRES DRILL BIT 4 3/4" [120 MM.]	05982				



**CATEGORY: PRO**
**MATERIAL: PORCELAIN TILE**
**ELECTRIC DRILL WITHOUT PERCUSSION**
**EASY GRES DRILL BIT SETS Ø 7/32" TO 1/2" (6 - 12 MM.)**

- The EASY GRES guide allows holes both vertically and horizontally, thanks to its functional design incorporating a water tank with flow control valve.
- The EASY GRES guide attaches easily to any surface, thanks to its renewable adhesives.

	REF.	RPM			
<b>EASY GRES DRILL BIT 7/32" (6 MM.) SET</b>	04927	1000 max.	1" 25 mm	10	800
<b>EASY GRES DRILL BIT 5/16" (8 MM.) SET</b>	04928				420
<b>EASY GRES DRILL BIT 3/8" (10 MM.) SET</b>	04929				800
<b>EASY GRES DRILL BIT 1/4" AND 3/8" (6.5 AND 10 MM.) SET</b>	04909				810
<b>KIT EASY GRES BITS Ø 6,8,10 AND 12 MM.</b>	04904	1000			



**CATEGORY: PRO**
**MATERIAL: PORCELAIN TILE**
**ELECTRIC DRILL WITHOUT PERCUSSION**
**KIT EASY GRES PLUS**

- The kit includes:
- MULTIDRILL guide.
- Water tank and hose.
- EASY GRES drills Ø 3/4", 1 1/8", 1 3/8", 1 3/4", 2", 2 1/2" and 3" (20, 28, 35, 43, 50, 65 and 75 mm.) and case.

	REF.	RPM		
<b>KIT EASY GRES PLUS</b>	50937	500 max.	1 1/8" 27 mm	1

**CATEGORY: PRO**
**MATERIAL: PORCELAIN TILE**
**ELECTRIC DRILL WITHOUT PERCUSSION**
**EASY GRES DRILL BIT Ø 1 3/8 (35 MM.) SET**

- The kit includes:
- MULTIDRILL guide.
- Water tank and hose.
- EASY GRES drill bit Ø 1 3/8" (35 mm).

	REF.	RPM		
<b>EASY GRES DRILL BIT Ø 1 3/8" (35 MM.) SET</b>	50921	500 max.	1 1/8" 27 mm	1

# ACCESSORIES FOR DIAMOND DRILL BITS

## • GUIDANCE SYSTEMS, AND OTHER ACCESSORIES FOR DIAMOND DRILLS.



### ◆ CATEGORY: PRO

#### TANK FOR MULTIDRILL GUIDE

- Bottle of 1200 ml. volume, with manual pressure pump.
- Includes 2 m. hose.

	REF.	
TANK AND HOSE FOR MULTIDRILL GUIDE	50947	1



### ◆ CATEGORY: SUPERPRO

#### MULTIDRILL GUIDE

- By fixing with suction cup, allows horizontal and vertical holes in the right place, preventing the drill bit from slipping.
- Compatible with all Rubi diamond drill bits, Ø 6 to 83 mm.
- Includes hose and tank connection (Ref. 50947).

	REF.	
MULTIDRILL GUIDE (MÁX. Ø 83 MM.)	50944	1



### ◆ CATEGORY: PRO

#### MULTIDRILL PLUS RM GUIDE

- By fixing the guide with the suction cup, allows horizontal and vertical holes in the correct place, preventing the drill bit from slipping on any type of surface: smooth, rough or slightly structured.
- Compatible with all Rubi diamond drill bits, Ø 6 to 120 mm.
- Metal centring guide for greater wear resistance.
- Includes hose and tank connection (Ref. 50947).

	REF.	
MULTIDRILL PLUS GUIDE RM (MAX. Ø 120 MM)	51908	1



### ◆ CATEGORY: SUPERPRO MATERIAL: PORCELAIN TILE GRINDER ELECTRIC DRILL WITHOUT PERCUSSION

#### DRYGRES DRILL BITS

- For dry drilling in ceramic, porcelain, natural stone and other materials.
- Maximum operating speed 14,000 r.p.m. M14 thread finish.
- They can be used both with grinders or drill without hammer, using the included adapter kit.
- Usable with grinder. Supplied in blister.



	REF.	RPM		
M14 ADAPTER FOR ELECTRIC DRILL	05976	14000 max.	1 3/8" 36 mm	1







		REF	Ø MM	Ø INCH				USE	
<b>DIAMOND DRILL BITS</b>	<b>DRYGRES PREMIUM</b>	Tile, Ceramic tiles, Porcelain tiles, Granite, Marble		06900	6	14/64"	max. 14.000	 GRINDER   ELECTRIC DRILL Without percussion   MULTIDRILL GUIDE / MULTIDRILL PLUS RM	
		06915	7	1/4"					
		06918	8	5/16"					
		06919	10	13/32"					
		06929	12	1/2"					
		06971	20	3/4"					
		06972	28	1 1/8"					
		06973	35	1 3/8"					
		06974	43	1 3/4"					
		06975	50	2"					
		06976	60	2 3/8"					
		06977	65	2 1/2"					
	06978	68	2 11/18"						
	06979	75	3"						
	06980	85	3 3/8"						
	<b>DRYGRES</b>	Tile, Ceramic tiles, Porcelain tiles, Granite, Marble		05988	6	14/64"	max. 14.000	36	 GRINDER   ELECTRIC DRILL Without percussion Use with adapter (Ref. 05976)   MULTIDRILL GUIDE / MULTIDRILL PLUS RM
		05994	7	1/4"					
		05989	8	5/16"					
		05990	10	13/32"					
		05991	12	1/2"					
		04910	20	3/4"					
		57903	25	1"					
		04911	28	1 1/8"					
		04912	35	1 3/8"					
04913		43	1 3/4"						
04914		50	2"						
04915		60	2 3/8"						
04916		65	2 1/2"						
04917		68	2 11/18"						
05992		75	3"						
57904		80	3 1/8"						
57906		85	3 3/8"						
57907		100	3 15/16"						
57908	120	4 3/4"							
<b>DRYGRES 4DRILL</b>	Coating ceramics, Ceramic tiles, Porcelain tiles, Natural Stone, Piedra Artificial		05923	6	14/64"	min. 1.000	40	 ELECTRIC DRILL Without percussion  Without percussion and adapter (Ref. 04992)	
	05924	8	5/16"						
	05926	10	13/32"						
	05927	12	1/2"						
	05928	14	9/16"						
	05929	20	3/4"						
	05970	28	1 1/8"						
05971	35	1 3/8"							
<b>TUNGSTEN CARBIDE DRILL BITS</b>	Tile		04962	35	1 3/8"	max. 800	18	 ELECTRIC DRILL Without percussion  Without percussion and adapter (Ref. 04992)	
	04964	45	1 3/4"						
	04965	55	2 1/4"						
	04968	85	3 1/4"						

Recommended Speed

Max. drilling depth



# GRINDING & POLISHING

---

Grinding wheels and blades  
Blades and polishing pads



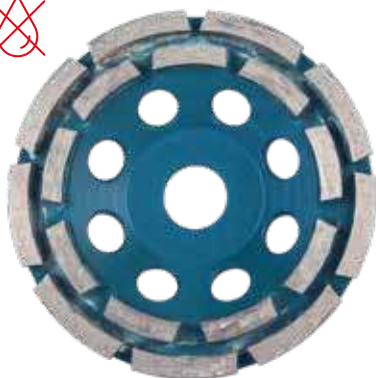

## GRINDING WHEELS

1  
Prepare

CATEGORY: SUPERPRO

MATERIAL: CONCRETE

LONG LIFE

## CONCRETE DOUBLE ROW GRINDING CUP

- Grinding cup with double row of sintered segments for grinding and edge finishing on concrete surfaces.
- Laser welding. Coarse grinding finish. Heavy-Duty steel core.
- For GRINDERS use.
- Maximum perimeter speed: 15.300 RPM (Ref. 05917) and 12.250 RPM (Ref. 05918).

	REF.						RPM	
GRINDING CUP WHEEL CONCRETE DOUBLE ROW 0100	05917	3 7/8" 100 mm	7/8"	1/4"	3/4"	15300 max	1	
GRINDING CUP WHEEL CONCRETE DOUBLE ROW 0125	05918	4 7/8" 125 mm	22,2 mm	6 mm	19 mm	12250 max		



CATEGORY: SUPERPRO

MATERIAL: CONCRETE

FAST

## CONCRETE FAN GRINDING CUP

- Fan shaped grinding cup with sintered segments for fast grinding and edge finishing on concrete surfaces.
- Laser welding. Coarse grinding finish. Heavy-Duty steel core.
- For GRINDERS use.
- Maximum perimeter speed: 15.300 RPM (Ref. 05919) and 12.250 RPM (Ref. 05920)

	REF.						RPM	
GRINDING CUP WHEEL CONCRETE FAN CUP 0100	05919	3 7/8" 100 mm	7/8"	1/4"	7/8"	15300 max	1	
GRINDING CUP WHEEL CONCRETE FAN CUP 0125	05920	4 7/8" 125 mm	22,2 mm	5 mm	23,5 mm	12250 max		



CATEGORY: SUPERPRO

MATERIAL: NATURAL STONE

LONG LIFE

## STONE GRINDING CUP

- Turbo sintered grinding cup for grinding and edge finishing on natural stone surfaces.
- Laser welding. Coarse grinding finish. Heavy-Duty steel core.
- For GRINDERS use.
- Maximum perimeter speed: 15.300 RPM (Ref. 05919) and 12.250 RPM (Ref. 05920)

	REF.						RPM	
GRINDING CUP WHEEL TURBO STONE 0100	05921	3 7/8" 100 mm	M14" M14 mm	1/4"	3/4"	15300 max	1	



CATEGORY: SUPERPRO

MATERIAL: EPOXY

## EPOXY-FIBER GRINDING CUP

- PCD grinding cup for fast removal of epoxy, paint, acrylics or other elastic coatings.
- High frequency welding. Heavy-Duty steel core. Medium grinding finish.
- For GRINDING use.
- Maximum perimeter speed: 12.250 RPM

	REF.						RPM	
GRINDING CUP WHEEL EPOXY, FIBRE, PCD 0125	05922	4 7/8" 125 mm	7/8"	1/8"	3/8"	12250 max	1	

## CUTTING &amp; GRINDING BLADES

2  
Cut & Drill

CATEGORY: SUPERPRO

NO VIBRATIONS

GOOD FINISH

## CUTTING &amp; GRINDING BLADES

- For cutting and grinding soft natural stone and ceramic tiles and synthetic materials.
- For adjustment cuts and grinding on all types of porcelain and hard materials.
- Electroplated continuous rim blade.
- Two-sided and reversible blade for a better performance.
- For grinders use. Connection: M14 thread.

REF.					RPM		
ECD 115 2IN1 SUPERPRO	31964	4 1/2" 115 mm	M14*	1/8"	1/4"	13300 max.	1
ECD 125 2IN1 SUPERPRO	31965	4 7/8" 125 mm	M14 mm	18 mm	5,6 mm	12250 max.	



## GRINDING CUTTERS



CATEGORY: SUPERPRO	MATERIAL: PORCELAIN TILE	QUALITY FINISH	LONG LIFE	LANDSCAPING
--------------------	--------------------------	----------------	-----------	-------------

**FULL BULLNOSE GRINDING BIT**

- For full bullnose edge grinding on porcelain, natural stone and landscaping materials.
- These cutters can easily produce bevels on worktops, steps, swimming pool coping, tree surrounds, kerbs, etc.
- For use with a grinder with M14 fitting.
- Diamond fixed by means of a vacuum brazing process.

	REF.	1" 50 mm	RPM	3/4" 20 mm	1.014116 lb 0,46 kg	1
<b>FULL BULL NOSE</b>	52938		14000 max.			



CATEGORY: SUPERPRO	MATERIAL: PORCELAIN TILE	QUALITY FINISH	LONG LIFE	LANDSCAPING
--------------------	--------------------------	----------------	-----------	-------------

**HALF BULLNOSE GRINDING BIT**

- For half bullnose edge grinding on porcelain, natural stone and landscaping materials.
- These cutters can easily produce bevels on skirting, steps, worktops, swimming pool coping, etc.
- For use with a grinder with M14 fitting.
- Diamond fixed by means of a vacuum brazing process.

	REF.	1" 50 mm	RPM	3/4" 20 mm	0.970024 lb 0,44 kg	1
<b>HALF BULL NOSE</b>	52939		14000 max.			





## DIAMOND FLAP DISCS



 **CATEGORY: SUPERPRO**
 **MATERIAL: PORCELAIN TILE**
**FAST**
**GOOD FINISH**
**LONG LIFE**

## DIAMOND FLAP DISCS

- For grinding ceramic, porcelain, sintered stone and natural stone.
- Fast grinding with a long life due to the ratio of diamond concentration to diamond grit spacing.
- Excellent for mitres and bevels.
- Ideal for edge and surface grinding.
- It comes with an aluminium M14 ADAPTER for use with the grinder to reduce vibrations and provide better stability during work.
- Electroplated.
- Dry and wet grinding.
- Very good finish.

	REF.		RPM		
<b>DIAMOND FLAP DISC 50/60 COARSE GRIT 0115</b>	32921	4 1/2" 115 mm	10500	0,925932 lb 0,42 kg	1
<b>DIAMOND FLAP DISC 100/120 MEDIUM GRIT 0115</b>	32927				
<b>DIAMOND FLAP DISC 200 FINE GRIT 0115</b>	32931				
<b>DIAMOND FLAP DISC 50/60 COARSE GRIT 0125</b>	32937	4 7/8" 125 mm	9650	0,925932 lb 0,42 kg	1
<b>DIAMOND FLAP DISC 100/120 MEDIUM GRIT 0125</b>	32938				
<b>DIAMOND FLAP DISC 200 FINE GRIT 0125</b>	32939				

## GRINDING BLADES



CATEGORY: PRO

MATERIAL: PORCELAIN TILE

## GRINDING BLADES

- VACUUM BRAZED embossed plate.
- For edges and surfaces grinding of natural stone, all kind of ceramic tiles and paint or resin coatings.
- For GRINDERS use.
- Maximum recommended speed: 15,300 RPM.
- Fine grinding finish.(Ref.31974)
- Coarse grinding finish.(Ref.31979)

	REF.					RPM	
<b>VDF 100 FINE PRO</b>	31974	3 7/8" 100 mm	7/8" 22,2 mm	1/8" 2,1 mm	7/8" 23 mm	15300 max	1
<b>VDF 100 COARSE PRO</b>	31979			1/8" 2,4 mm			

## BEVELLING WHEELS



CATEGORY: SUPERPRO

MATERIAL: PORCELAIN TILE

GOOD FINISH

## FINE GRIT PRO-EDGER BEVELLING WHEEL





- Grinding wheel for bevelling.
- Diamond grits fixed by means of a vacuum brazing system.
- Recommended for use with ANGLE GRINDERS.
- Recommended use between 9,000 – 12,000 rpm to achieve greater durability of the wheel.
- Round finish available on 5 and 10 mm radius.
- Internal diameter: 16.1 mm (M16 thread).
- For exclusive use with PRO-EDGER.

	REF.				RPM	
<b>R.5 FINE GRAIN PRO-EDGER BEVELLING WHEEL</b>	16957	2 5/8" 66 mm	M16"	1/4" 6 mm	12000 max.	5
<b>R.10 FINE GRAIN PRO-EDGER BEVELLING WHEEL</b>	16958	2" 76 mm	M16 mm	3/8" 11 mm		1

**CATEGORY: SUPERPRO**
**MATERIAL: PORCELAIN TILE**
**GOOD FINISH**

### FINE GRIT PRO-EDGER MITRING WHEEL





- Grinding wheel for mitring.
- Diamond grits fixed by means of a vacuum brazing system.
- Recommended for use with ANGLE GRINDERS.
- Recommended use between 9,000 – 12,000 rpm to achieve greater durability of the wheel.
- 45° type tool with 1–2 mm edge.
- Internal diameter: 16.1 mm (M16 thread).
- For exclusive use with PRO-EDGER.

	REF.				RPM	
<b>45X20 FINE GRAIN PRO-EDGER MITRING WHEEL</b>	16946	3 3/4" 94 mm	M16" M16 mm	3/4" 20 mm	12000 max.	5
<b>45X15 FINE GRAIN PRO-EDGER MITRING WHEEL</b>	16985	3 1/4" 84 mm		5/8" 15 mm		

**CATEGORY: SUPERPRO**
**MATERIAL: PORCELAIN TILE**
**FAST**

### TURBO TWIST COARSE GRIT PRO-EDGER MITRING WHEEL

- Grinding wheel for mitring.
- Diamond grits fixed by means of a vacuum brazing system.
- Recommended for use with ANGLE GRINDERS.
- Recommended use between 9,000 – 12,000 rpm to achieve greater durability of the wheel.
- The TURBO TWIST model can be used for grinding before finishing with a fine grit, as its grooved design can chip the tile profile.
- Internal diameter: 16.1 mm (M16 thread).
- For exclusive use with PRO-EDGER.

	REF.				RPM	
<b>45X15 TURBO TWIST COARSE GRAIN PRO-EDGER MITRING WHEEL</b>	16984	3 1/4" 84 mm	M16" M16 mm	5/8" 15 mm	12000 max.	5



## POLISHING PADS



CATEGORY: SUPERPRO

MATERIAL: NATURAL STONE

QUALITY FINISH

## DRY POLISHING DIAMOND PADS

- Range of floppy discs Ø100 mm for polishing, dry, of concrete, marble, granite and other ornamental natural stones.
- It allows removing scratches and surface damage quickly and easily.
- Maximum operating speed: 3,000 rpm.
- Different granulometry.
- # 50, # 100 and # 200 for roughing.
- # 400, # 800, # 1500 and # 3000 polishing and close the pore.
- VELCRO® fastening blade to holder ref. 62986.

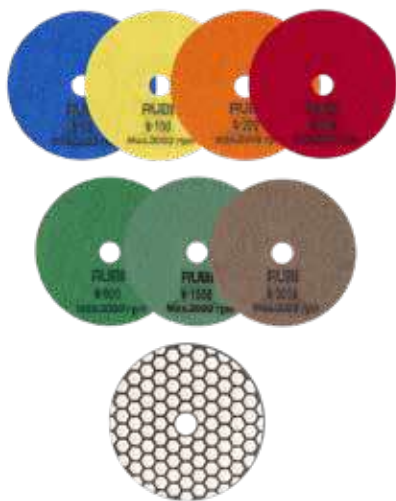

	REF.		
DIAMOND PADS DRY POLISHING Ø100 MM - GRAIN # 50	62970	3 7/8" 100 mm	1
DIAMOND PADS DRY POLISHING Ø100 MM - GRAIN #100	62971		
DIAMOND PADS DRY POLISHING Ø100 MM - GRAIN #200	62972		
DIAMOND PADS DRY POLISHING Ø100 MM - GRAIN #400	62973		
DIAMOND PADS DRY POLISHING Ø100 MM - GRAIN #800	62974		
DIAMOND PADS DRY POLISHING Ø100 MM - GRAIN #1500	62975		
DIAMOND PADS DRY POLISHING Ø100 MM - GRAIN #3000	62976		



CATEGORY: SUPERPRO

MATERIAL: NATURAL STONE

QUALITY FINISH

## DRY DIAMOND POLISHING PAD BUFF BL.

- Ø100 mm floppy disc for the final buffing, dry, of concrete, marble, granite and other ornamental natural stones.
- Get a natural and long-lasting shine
- Maximum operating speed: 3,000 rpm.
- VELCRO® fastening blade to holder ref. 62986.



	REF.		
DRY DIAMOND POLISHING PAD Ø100 MM BUFF BL.	62977	100	1

CATEGORY: SUPERPRO

## PAD SUPPORT FOR POLISHING AND BUFFING

- Fixing brackets for flexible polishing and buffing blades Ø100 mm.
- Compatible with jobs dry and water-cooled.
- VELCRO fastening.
- Connection polisher / grinder with M14 thread.



	REF.		
SUPPORT FLOPPY PAD Ø100MM M14	62986	3 7/8" 100 mm	1



# MANUAL POLISHING PADS



◇ CATEGORY: SUPERPRO

■ MATERIAL: PORCELAIN TILE

QUALITY FINISH

LONG LIFE

## MANUAL POLISHING PADS

- Range of diamond rubber pads for roughing and edge polishing, cutting and surfaces of natural stone and ceramic tile.
- Semi-flexible. Good adaptation to the user's hand.
- Wet use is recommended.
- Different grain sizes:
  - # 60, # 120 and # 200 for roughing.
  - # 400 for polishing.
- Dimensions of the diamond plate: 55x90 mm.
- Rubber pad dimensions: 58x94x30 mm.



REF.



	REF.	
DIAMOND POLISHING PAD GRAIN # 60	61974	10
DIAMOND POLISHING PAD GRAIN #120	61975	
DIAMOND POLISHING PAD GRAIN #200	61976	
DIAMOND POLISHING PAD GRAIN #400	61977	





# MIXING

---

Electric mixers  
Mixing paddles



# RUBIMIX E-10 ENERGY CAS

## FREEDOM OF MOVEMENT.

For cementitious adhesives, resins, paints and other materials.



CATEGORY: PREMIUM



POWER



LIGHT



CAS BATTERY COMPATIBLE



Brushless



FAST-IN



CE



SAFETY

- **Brushless motor. Maintenance-free and increases the product's lifespan. Maximum efficiency.**
- **Powered by a CAS Li-Ion 18V 5.2Ah battery pack, compatible with METABO cordless tools and all of those that form part of the CAS 18V platform.**
- **Light and strong. Maximum reliability.**
- **Dual bi-material grip handle. Better ergonomics, comfort and stability.**
- Equipped with a 2-speed gearbox.
- Progressive switch (RPM control) to optimise the mixing of each material.
- Switch safety lock prevents unintentional start-up.
- LED battery-charge indicator.
- Connection to mixing paddles with M14 thread and FAST-IN adapter (included).
- Double-insulated motor.



	REF.			RPM			
RUBIMIX E-10 ENERGY CAS EU	26570	√	18 V	1ª 0-420/ 2ª 0-700	18.95956 lb 8,6 kg	1	20
RUBIMIX E-10 ENERGY CAS UK	26571				18.95956 lb 8,6 kg		
RUBIMIX E-10 ENERGY CAS USA	26572				18.95956 lb 8,6 kg		
RUBIMIX E-10 ENERGY CAS NO BAT/CHARG.	27913				18.95956 lb 8,6 kg		
BATTERY CASE LI-POWER 18V 5.2AH	85902		18V				

ACCESSORIES		Mixer Paddles FAST-IN 3HELIX		RUBIMIX-50 N

COMPATIBILITY	
RUBIMIX E-9 ENERGY CAS	18 V 5.2 Ah
RUBIMIX E-10 ENERGY CAS	18 V 5.2 Ah
ANGLE GRINDER TECH	18 V 5.2 Ah
RUBI LUMEO	18 V 5.2 Ah
QUAKE ENERGY CAS	18 V 2.0 Ah
RUBI TRILLER ENERGY CAS	12 V 4.0 Ah

## RUBIMIX E-9 ENERGY CAS

### LIGHT, RELIABLE & RESISTANT

Ideal for the mixing of cement adhesives, resins, paints, and other materials.



CATEGORY: PREMIUM



USE: PROFESSIONAL



RELIABILITY



CAS BATTERY COMPATIBLE



- **SAFETY AND MORE COMFORTABLE.** Equipped with a safety lock to avoid involuntary startup and a soft start device to control the acceleration of the paddle.
- **ELECTRONIC RPM REGULATOR.** Accurate control of the rpm with the 5 positions dial.
- **CAS PLATFORM TECHNOLOGY.** Li-Power 18V 5,2 Ah CAS battery. Portability and manageability, free of cables.
- **BRUSLESS MOTOR.** High efficiency with increased battery performance. Less maintenance.
- Double handled with bi-material handles. Improves ergonomics, comfort and stability.
- LED indicator of battery charge level.
- 5.2Ah battery, at 100%, allows user to mix 3 bags of 25kg of tile adhesive. Not recommended to mix more than 25kg in once.
- Double insulation of the motor.
- IP20 protection.
- Maximum mixing paddle's head diameter: 120 mm
- Equipped with FAST-IN adapter, also allows to use mixing paddle rods with M14 thread.
- Includes a M120 FAST-IN detachable paddle.
- Includes transport case and tools to remove the FAST-IN adapter and to use M14 mixing paddles.



	REF.			RPM			
RUBIMIX E-9 ENERGY CAS EU	61993	√	18 18 V	1ª 0-700	11.025 lb 5 kg	1	-
RUBIMIX E-9 ENERGY CAS UK	61994						
RUBIMIX E-9 ENERGY CAS USA	61995						
RUBIMIX-E9 ENERGY CAS NO BAT/CHARG.	61996						
BATTERY CASE LI-POWER 18V 5.2AH	85902		18V				

\*The pictures of this product might be slightly different to its final version.

ACCESSORIES		Mixer Paddles FAST-IN 3HELIX		Mortar mixer paddle Thread M14 3 HELIX		RUBIMIX-50 N

**COMPATIBILITY**

RUBIMIX E-9 ENERGY CAS	18 V 5.2 Ah
RUBIMIX E-10 ENERGY CAS	18 V 5.2 Ah
ANGLE GRINDER TECH	18 V 5.2 Ah
RUBI LUMEO	18 V 5.2 Ah
QUAKE ENERGY CAS	18 V 2.0 Ah
RUBI TRILLER ENERGY CAS	12 V 4.0 Ah

## RUBIMIX-9 POWER MAX

**POWERFUL MULTIPURPOSE ELECTRIC MIXER, SUITABLE FOR CEMENTITIOUS ADHESIVES, RESINS, PAINT, AND OTHER MATERIALS.** Facilitates a homogeneous mixing of materials, avoiding the formation of bubbles and/or lumps.



CATEGORY: PREMIUM



POWER  
2100W

**W**  
2100 W

**FAST  
IN**

**PROTECTED  
DESIGN**

**CE**

**EAC**

**UK  
CA**

- **Electronic speed controller (rpm regulation) to optimise the mixing of each material.**
- **Equipped with 2 speeds gearbox (490/880 rpm).**
- **Mixing paddles connection through exclusive RUBI FAST-IN head for fast paddle change.**
- **Greater electrical safety thanks to double isolation.**
- Easy and intuitive use.
- Attractive and functional design.
- Ergonomic bi-material handle with improved grip that provides greater. Comfort & stability.
- Chassis in technical plastic, light & resistant.
- Maximum reliability & durability.
- Anti-ignition security system. Prevents inadvertent start-up.
- Soft start system.
- Ø140mm triple helix mixing paddle included (M14 thread continuous full rod) for mortar and cementitious adhesives.
- Direct access to engine brushes for a fast and easy maintenance. Spare brushes and 19 & 22 mm keys included.
- Available version with carrying case (ref.26981).
- Compatible with drill holder and RUBI mixing paddles range.





**3+1**  
YEARS  
WARRANTY

**1** Prepare 2 3 4 5

	REF.		W				
<b>RUBIMIX-9 POWER MAX</b>	26980	-	2100 2100 W	230V/50-60Hz	16.5345 lb 7.5 kg	2	12
<b>RUBIMIX-9 POWER MAX + CASE</b>	26981	✓			25.57336 lb 11.6 kg		

ACCESSORIES		Mixer Paddles FAST-IN 3HELIX		RUBIMIX-50 N



## RUBIMIX-9 SUPERTORQUE

**VERSATILE ELECTRIC MIXER, SUITABLE FOR CEMENTITIOUS ADHESIVES, RESINS, PAINTS AND OTHER MATERIALS.**

Facilitates homogeneous mixing of the materials and prevents the creation of bubbles and/or lumps.



  
CATEGORY: SUPERPRO



**POWER**  
1800W

**W**  
1800 W

**PROTECTED  
DESIGN**

**CE**

**EAC**

**UK  
CA**

- **Electric mixer with high torque.**
- **Electronic speed controller (rpm control) to OPTIMISE the mixing of each material.**
- **Equipped with a mechanical 2 SPEED gearbox (450/780 rpm).**
- **Better electrical SAFETY thanks to its double insulation.**
- ATTRACTIVE and FUNCTIONAL Design.
- Connection to mixing paddles with M14 thread.
- Double handle with bi-material grip providing better ERGONOMICS, COMFORT and STABILITY.
- Chassis in TECHNICAL, LIGHT, and STRONG plastic. Maximum RELIABILITY AND DURABILITY.
- SAFETY on button. Prevents unintentional start-up.
- Smooth start system.
- Direct access to the motor's brush housing for quick and easy maintenance.
- Includes mixing paddle with 3 helixes of 140 mm diameter for mortars and cementitious adhesives.
- Option to couple a RUBI FAST-IN adapter for paddles (NOT included).
- Includes brushes and 19 and 22 mm spanners.
- Version available with transport case (ref. 26974).
- Compatible with chucks and range of mixing paddles RUBI.



**3+1**  
YEARS  
WARRANTY

**1** · 2 · 3 · 4 · 5  
Prepare

	REF.		W		RPM			
RUBIMIX-9 SUPERTORQUE	26970	-	1800 1800 W	230V-50/60Hz.	1ª 0-450 / 2ª 0-780	11.24346 lb 5.1 kg	2	12
RUBIMIX-9 SUPERTORQUE UK	26971	-		110V-50/60Hz.				-
	26972			220V-50/60Hz.				12
RUBIMIX-9 SUPERTORQUE USA + CHUCK	26973	-		120V-50/60Hz.				12
RUBIMIX-9 SUPERTORQUE + CASE	26974	✓		230V-50/60Hz.				19.51071 lb 8.85 kg
RUBIMIX-9 SUPERTORQUE + CHUCK	26975	-	11.24346 lb 5.1 kg					

ACCESSORIES		Mortar Mixer M14 Thread 3 ZN-Zinc plated HELIX		Mixer Paddles FAST-IN 3HELIX		RUBIMIX-50 N
-------------	--	---	--	---------------------------------	--	--------------





# RUBIMIX-16 ERGOMAX

## INNOVATIVE AND ERGONOMIC

For cementitious adhesives, resins, paints and other materials.



<b>W</b> 1600 W	<b>FAST-IN</b>	<b>PATENTED</b>
--------------------	----------------	-----------------

**CATEGORY: SUPERPRO**

**POWER**  
1600W

**REGULABLE**

**CE EAC UK CA**

- **Handle adjustable in height. Ergonomics adaptable to each user.**
- **Powerful 1600W motor for greater mixing capacity and high reliability.**
- **New and improved handle. Comfort and stability.**
- **Quick Connect System FAST-IN. Change rod without tools.**
- Electric mixer mortar powerful 1600 W.
- Double insulation.
- Gearbox with 2 speeds (1st 0-430 rpm / 2nd 0-570 rpm).
- Electronic speed controller (R.P.M. regulation).
- Ø maximum of mixer 160 mm. Mixer paddle Ø 140 mm. FAST-IN (5 9/16 ") included.
- Thread Direct link for mixers with M14 finish. Weight: 4.6 kg. Electrical cable: 3 m.

	REF.		<b>W</b>				
<b>RUBIMIX-16 ERGOMAX 230V 50/60HZ</b>	24994		1600 1600 W	230V 50-60Hz	10.14116 lb 4.6 kg	2	24
<b>RUBIMIX-16 ERGOMAX 110V 50/60HZ UK</b>	24995	-		110V 50-60Hz			18
<b>RUBIMIX-16 ERGOMAX 230V 50/60HZ UK</b>	24996			230V 50-60Hz			24
<b>RUBIMIX-16 ERGOMAX 230V 50/60HZ W/CASE</b>	24998	✓					24

**ACCESSORIES**

	Mixer Paddles FAST-IN 3HELIX		RUBIMIX-50 N
--	------------------------------	--	--------------



# RUBIMIX-8 EASY PRO

**MULTI-MATERIAL ELECTRIC MIXER, SUITABLE FOR CEMENTITIOUS ADHESIVES, RESINS, PAINT, AND OTHER MATERIALS.** Facilitates a homogeneous mixing of materials, avoiding the formation of bubbles and/or lumps.



**CATEGORY: SUPERPRO**

**POWER**  
1400  
1400 W

**EASY HANDLING**



- **1400 W Electric Motor.**
- **Mixing paddles connection through M14 thread.**
- **Greater electrical SAFETY thanks to double isolation.**
- **EASY and INTUITIVE use. ATTRACTIVE and FUNCTIONAL design.**
- Ergonomic bi-material handle with improved grip that provides greater comfort & stability.
- Chassis in technical plastic, light & resistant. maximum reliability & durability.
- Anti-ignition security system. Prevents inadvertent start-up.
- Includes Ø4" 3/4 (Ø120 mm) red triple helix split mixing paddle (M14 thread continuous full rod) for mortar and cementitious adhesives.
- Direct access to engines brushes for a fast and easy maintenance.
- Spare brushes and 3/4" & 7/8" (19 & 22 mm) keys included.
- Compatible with drill holder and RUBI mixing paddles range.

	REF.		W		RPM				
<b>RUBIMIX-8 EASY PRO EU</b>	16903	No	1400 1400 W	230V-50/60Hz.	0-700 0-700 RPM	10.714356 lb 4.86 kg	12.67645 lb 5.75 kg	2	32
<b>RUBIMIX-8 EASY PRO UK</b>	16905	-	1400	220V-50-60Hz.	1ª 0-700	10.427758 lb 4.73 kg			24
<b>RUBIMIX-8 EASY PRO USA</b>	16906			120V-50-60Hz.					18

ACCESSORIES		Mortar Mixer M14 Thread 3 ZN-Zinc plated HELIX		Mortar mixer paddle Thread M14 3 HELIX		RUBIMIX-50 N
-------------	--	---	--	---	--	--------------



# RUBIMIX-9 N

## VERSATILITY BY CHANGING THE MIXING PADDLE.

For cementitious adhesives, resins, paints and other materials.



**CATEGORY: SUPERPRO**

**POWER**  
1200W

**VERSATILITY**



- **Bimaterial double handle grip. Improved ergonomics and comfort.**
- **2 speed gearbox and electronic controller to optimise the mixing of each material.**
- **Interchangeable mixing paddle with M14 connection. Greater versatility.**
- **Made of lightweight and durable materials for maximum reliability.**
- Power: 1200 W.
- Double insulation.
- Direct connection M14 thread.
- Electronic regulator (1st 0-650 r.p.m. / 2nd 0-850 r.p.m.). Ø maximum paddle: 5" 1/2 (140 mm).
- Ø 4 3/4" (120 mm.) mixing paddle included.

	REF.		W		RPM				
<b>RUBIMIX-9 N</b>	25940	-	1200 1200 W	210-240V 50-60 Hz.	1ª 0-650 / 2ª 0-850	12.1253 lb 5,5 kg	2	24	
<b>RUBIMIX-9 N UK</b>	25942			110-130V 50-60 Hz.					
	25944			210-240V 50-60 Hz.					
<b>RUBIMIX-9 N + CHUCK</b>	24986			110-130V 50-60 Hz.					12.34576 lb 5,6 kg
<b>RUBIMIX-9 N USA + CHUCK</b>	24949			210-240V 50-60 Hz.					17.19588 lb 7,8 kg
<b>RUBIMIX-9 N + CASE</b>	24958	✓					18		

**ACCESSORIES**

- Mortar Mixer M14 Thread 3 ZN-Zinc plated HELIX
- Mortar mixer paddle Thread M14 3 HELIX
- RUBIMIX-50 N

# MIXING PADDLES FAST-IN

FAST-IN



**CATEGORY: SUPERPRO**

**FAST-IN PADDLE ADAPTER**

- Adapter for use of the FAST-IN rods.
- Transform the threaded connection M14x2 quick-connect system FAST-IN.
- Adaptable to any mixer with M14x2 thread.

	REF.	
FAST-IN ADAPTER	76907	1

FAST-IN



**CATEGORY: SUPERPRO** **TILE ADHESIVE** **FAST-IN CONNECTION**

**MIXER PADDLES FAST-IN 3HELIX**

- To mix cement mortars.
- Helix head with 3 paddles for better mixing. Increases performance by 15% compared to the 2-blade head.
- Less effort in mixing.
- Less vibrations. Greater comfort.
- Fast connection without tools FAST-IN.
- Compatible with RUBIMIX E-10 ENERGY CAS, RUBIMIX-9 POWER MAX, RUBIMIX-16 ERGOMAX or FAST-IN (Ref. 76907) Adaptable to any mixer with M14x2 connection.

	REF.					
MIXER PADDLE M-120-FI 3H	76942	33.069-55.115 lb 15-25 kg	23 5/8"	4 3/4" 120 mm	2	-
MIXER PADDLE M-140-FI 3H	76943	55.115-88.184 lb 25-40 kg	600 mm	5 1/2" 140 mm		84



# MIXING PADDLES

• ADAPTABLE TO RUBI MIXERS AND OTHER BRANDS.



**CATEGORY: PRO**

**TILE ADHESIVE**

**NON OXIDABLE**

## MORTAR MIXER M14 THREAD 3 ZN-ZINC PLATED HELIX

- For mixing cement-based mortars.
- Mixing paddle with zinc treatment.
- Paddle head with 3 blades for more efficient mixing. 15% performance improvement compared to heads with two blades.
- Reduces the effort for the electric mixer during the mixing process.
- Generates less vibration. Increased comfort.
- Connection by M14 x 2 thread.
- Can be adapted directly to RUBIMIX range and other brands.

	REF.				
<b>MORTAR MIXER PADDLE M-120-R 3H ZN</b>	76971	33.069-55.115 lb 15-25 kg	23 5/8" 600 mm	4 3/4" 120 mm	6
<b>MORTAR MIXER PADDLE M-120-R 3H LONG ZN</b>	76972	55.115-88.184 lb 25-40 kg	29 7/8" 760 mm		
<b>MORTAR MIXER PADDLE M-140-R 3H ZN</b>	76973	66.138-132.276 lb 30-60 kg	23 5/8" 600 mm	5 1/2" 140 mm	2



**CATEGORY: PRO**

**GYP SUM**

**NON OXIDABLE**

## PLASTER MIXER PADDLE THREAD M-14

- For mixing between 33.1 - 66.1 Lb. (15 - 25 kg.) of plaster.
- M14 x 2 thread connection.
- Adaptable directly to RUBIMIX range and other brands.

	REF.				
<b>PLASTER MIXER PADDLE P-120-R</b>	72954	33.069-66.138 lb 15-30 kg	23 5/8" 600 mm	4 3/8" 110 mm	2



**CATEGORY: PRO**

**TILE ADHESIVE**

**USE WITH DRILLS**

## MORTAR MIXER 3 HELIX

- To mix cement mortars.
- Helix head with 3 blades for higher efficient mixing.
- Adaptable to RUBIMIX range by chuck (Ref. 71967).

	REF.				
<b>MORTAR MIXER M-80 3H</b>	76945	22.046-33.069 lb 10-15 kg	15 3/4" 400 mm	3 1/8" 80 mm	6
<b>MORTAR MIXER M-100 3H</b>	76946	33.069-44.092 lb 15-20 kg	21 5/8" 550 mm	3 7/8" 100 mm	





**CATEGORY: PRO** **TILE ADHESIVE** **HIGHER PERFORMANCE**

**MORTAR MIXER PADDLE THREAD M14 3 HELIX**

- To mix cement mortars.
- Helix head with 3 paddles for better mixing. Increases performance by 15% compared to the 2-blade head.
- Less effort in mixing.
- Less vibrations. Greater comfort.
- M14 x 2 thread connection.
- Adaptable directly to RUBIMIX range and other brands.

	REF.				
<b>MORTAR MIXER PADDLE M-100-R 3H</b>	76917	33.069-44.092 lb 15-20 kg	21 5/8" 550 mm	3 7/8" 100 mm	6
<b>MORTAR MIXER PADDLE M-120-R 3H</b>	76918	33.069-55.115 lb 15-25 kg	23 5/8" 600 mm	4 3/4" 120 mm	2
<b>MORTAR MIXER PADDLE M-140-R 3H</b>	76919	55.115-88.184 lb 25-40 kg		5 1/2" 140 mm	
<b>MORTAR MIXER PADDLE M-160-R 3H</b>	76940	66.138-132.276 lb 30-60 kg		6 1/4" 160 mm	



**CATEGORY: PRO** **EPOXI RESIN** **USE WITH DRILLS**

**EPOXY MIXER PADDLE E-80**

- Special mixing between 2.2 - 4.4 Lb. (1 - 2 kg) of epoxy resins.
- 8 mm hexagonal finish.
- Adaptable to RUBIMIX range by chuck (Ref. 71967).

	REF.				
<b>EPOXY MIXER PADDLE E-80</b>	65939	2.2046-11.023 lb 1-5 kg	15 3/4" 400 mm	3 1/8" 80 mm	6



**CATEGORY: PRO** **LIQUIDS** **USE WITH DRILLS**

**LIQUID MIXER PADDLE - HEXAGONAL ROD**

- To mix liquid and low density materials.
- Adaptable to RUBIMIX range by chuck (Ref. 71967).

	REF.					
<b>LIQUID MIXER PADDLE L-80</b>	65933	11.023-33.069 lb 5-15 kg	15 3/4" 400 mm	3 1/8" 80 mm	6	462
<b>LIQUID MIXER PADDLE L-100</b>	65934	33.069-55.115 lb 15-25 kg	21 5/8" 550 mm	3 7/8" 100 mm		



**CATEGORY: PRO**

**RUBIMIX-50 N**

- With double thermal protection device.
- Blade speed: 60 r.p.m.
- For mixing up to 110 Lb. (50 kg.) of mortar (adhesive, facing cement, etc.)
- Integrated gearbox design for better performance in the transmission.
- Compact and easy to transport.

	REF.	
BUCKET FOR RUBIMIX-50-N	60202	1

**CATEGORY: SUPERPRO**

**CHUCK**



- Chuck attachable to the entire RUBIMIX range to work with hexagonal and round finishing rods below 12mm.
- Includes chuck key - S2 Ref. 71969.

	REF.	
CHUCK	71967	1

	<b>UPWARDS MOTION:</b> The material rises through the inner section of the mixing paddle and falls on the outside. This motion allows for a homogeneous mixture of viscous materials such as mortar, cement, glue, etc. Less effort and easier use.	M-120-R 3H ZN M-120-R 3H L ZN M-140-R 3H ZN M-80 3H M-100 3H	M-100-R 3H M-120-R 3H M-140-R 3H M-160-R 3H M-120-FI 3H M-140-FI 3H
	<b>PARALLEL MOTION:</b> The mixture is done horizontally so the materials flow in both directions (up/down) depending on the movement of the paddle. This motion is recommended for resins, bicomponents, liquids, etc. It reduces the amount of bubbles and lumps.	E-80 P-120-R	
	<b>DOWNWARD MOTION:</b> The material is pulled through the paddle's head and rises through the exterior. This motion is recommended for materials with a low viscosity such as paint, sealers, plaster, etc... The lumps are dissolved without splashing.	L-80 L-100	
	<b>COUNTER MOTION:</b> Both paddles work simultaneously generating a more intense mixture. Recommended for resilient and viscous materials such as mortars. Only for dual- paddle mixers.	M-120 DUPLEX	



# MIXING PADDLES

	REF		KG	LB	RPM	W	MM	INCH	MM	INCH	MM/INCH		
M-120-R 3H ZN	76971		15-25	33.1-55.1	300-500	950	600	23 5/8"	120	4 3/4"		M14 x 2	
M-120-R 3H L ZN	76972		25-40	55.1-88.2		950	760	29 15/16"					
M-140-R 3H ZN	76973		30-60	66.1-132.3	200-400	1200	600	23 5/8"	140	5 9/16"			
M-80 3H	76945		10-15	22-33.1	300-500	500	400	15 3/4"	80	3 3/16"		8	5/16"
M-100 3H	76946		15-20	33.1-44.1		700	550	21 11/16"	100	4"		10	13/32"
M-100 R 3H	76917					950	600	23 5/8"	140	5 9/16"	M14 x 2		
M-120 R 3H	76918		15-25	33.1-55.1	200-400	1500	160	6 5/16"					
M-140 R 3H	76919		25-40	55.1-88.2	300-500	950	600	23 5/8"	120	4 3/4"		FAST-IN	
M-160 R 3H	76940		30-60	66.1-132.3		1500			160	6 5/16"			
M-120 FI 3H	76942		15-25	33.1-55.1	200-400	1200	140	5 9/16"					
M-140 FI 3H	76943	25-40	55.1-88.2	300-500	950	400	15 3/4"	80	3 3/16"		8	5/16"	
E-80	65939	1-5	2.2-11	300-500	700	400	15 3/4"	80	3 3/16"		10	13/32"	
L-80	65933	5-15	11-33.1	300-600	400	400	15 3/4"	80	3 3/16"				
L-100	65934	15-25	33.1-55.1		500	550	21 11/16"	100	4"				
P-120 R	72954		15-30	33.1-66.1	300-500	950	600	23 5/8"	110	4 5/16"		M14 x 2	



Quantity to be mixed



Recommended speed (RPM)



Minimum drill power (W)



Total length



Ø of mixer



Rod shape



Material to be mixed



Hexagonal finish



Thread finish



Fast-in



Gypsum



Paint / Liquids



Tile adhesive



Epoxy resin



# TOOLS

## FOR FIXING TILES AND FINISHINGS



Trowels, notched trowels, floats, rubber trowels and spatulas  
Markers, chisels, templates and auxiliary tools for tiling  
Mallets, Nippers and Grout Mortar Applicators





# SELECTION TABLE

	 ADHESIVE MORTAR O PUTTY		
≤ 10 X 10 CM ≤ 4" X 4"			3 X 3 MM 1/8" X 1/8"
			4,5 X 4,5 MM 3/16" X 3/16"
FROM 10 X 10 TO 20X20 CM FROM 4" X 4" TO 8" X 8"			3 X 3 MM 1/8" X 1/8"
			6 X 6 MM 1/4" X 1/4"
FROM 10 X 10 TO 20X20 CM FROM 4" X 4" TO 8" X 8"			6 X 5 MM 1/4" X 7/32"
			6 X 6 MM 1/4" X 1/4"
FROM 20 X 20 TO 30 X 30 CM FROM 8" X 8" TO 12" X 12"			6 X 6 MM 1/4" X 1/4"
			8 X 8 MM 3/8" X 3/8"
FROM 20 X 20 TO 40 X 40 CM FROM 8" X 8" TO 16" X 16"			R10 R13/32"
FROM 30 X 30 TO 40 X 40 CM FROM 12" X 12" TO 16" X 16"			6 X 10 MM 1/4" X 13/32"
			10 X 10 MM 13/32" X 13/32"
* FROM 40 X 40 TO 60 X 60 CM * FROM 16" X 16" TO 24" X 24"			12 X 12 MM 1/2" X 1/2"
* FROM 60 X 60 TO 80 X 80CM * FROM 24" X 24" TO 32" X 32"			15 X 15 MM 9/16" X 9/16"
* >80 X 80 CM" * >32" X 32"			20 X 20 MM 13/16" X 13/16"
* >60 X 60 CM * > 24" X 24"			

Basic conditions:

≥80% Adhesive coverage [dry indoor surfaces].  
 Final layer thickness: 5 mm [3/16"].  
 BACK BUTTERING is not required.

\*Back buttering is mandatory when the required coverage is ≥95% [for outdoors or damp areas] or pieces larger than 40 x 40. [16"x16"].  
 To compensate for the bowing of the tile, add 2x\*\* to the tooth size (\*\* = deformation in the flatness of the tiles).

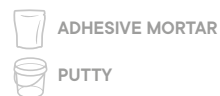



# TROWELS AND NOTCHED TROWELS

		WOODEN HANDLE						RUBIFLEX					PLASTIC HANDLE	
		●	INOX	●	INOX	●	●	INOX	●	INOX	●	45°	●	●
	TROWEL	65950	65960		65988	72915		75950	75970		72919		65951	25900
	SHARP		74948											
	3 x 3 mm 1/8 x 1/8"	65989				71923		72906	74936					25901
	4,5 x 4,5 mm 3/16 x 3/16"							74980	74937					25902
	6 x 6 mm 1/4 x 1/4"	65982			65958	71924	75955	72907	74938		75946	65966	25903	
	6 x 8 mm 1/4 x 3/8"			66968							66972			
	8 x 8 mm 3/8 x 3/8"	65984			65959	71925	75957	72908	74940		75947	65967	25905	
	8 x 10 mm 3/8 x 13/32"			66969							66973			
	10 x 10 mm 13/32 x 13/32"	65985			65983	71926	75958	72909	74941		75948	65968	25906	
	10 x 12 mm 13/12 x 1/2"			66970							66974			
	12 x 12 mm 1/2 x 1/2"	74947			73973		75959	74982	74942		75923		25907	
	15 x 15 mm 9/16 x 9/16"								76947					
20 x 20 mm 13/16 x 13/16"				75962										
	R10							72910			75924			
	YW							77923						



CLOSED HANDLE



CLOSED HANDLE 48cm/19"



OPEN HANDLE



SPATULA



TROWEL



SHARP EDGES



SQUARE



TRIANGULAR



ROUND



YW

● STEEL

● INOX

● WEEBER

## TROWELS AND NOTCHED TROWELS

1  
Prepare

CATEGORY: PREMIUM

CLOSED HANDLE



WOODEN

NEW!



## CLOSED WOODEN HANDLE TECH-FLEX NOTCHED TROWELS

- Closed Wooden handle for ergonomics.
- The curved and toothed plate is made of rubber for lightness and safety because it does not cut like metal films.
- The curved shape of the plate is comfort engineered because it reduces operator effort and reduces adhesive loss during application.

	REF.			
<b>CLOSED WOODEN HANDLE TECH-FLEX NOTCHED TROWELS (6X8)</b>	66968	1/4" 6 mm	3/8" 8 mm	-
<b>CLOSED WOODEN HANDLE TECH-FLEX NOTCHED TROWELS (8X10)</b>	66969	3/8" 8 mm	3/8" 10 mm	
<b>CLOSED WOODEN HANDLE TECH-FLEX NOTCHED TROWELS (10X12)</b>	66970	3/8" 10 mm	1/2" 12 mm	

CATEGORY: PREMIUM

OPEN HANDLE

RUBIFLEX

NEW!



## TECH-FLEX NOTCHED TROWELS

- Open RUBIFLEX handle for ergonomics.
- The trowel can be left resting on the edge of the carrycot.
- The curved and toothed plate is made of rubber for lightness and safety because it does not cut like metal films.
- The curved shape of the plate is comfort engineered because it reduces operator effort and reduces adhesive loss during application.

	REF.			
<b>TECH-FLEX NOTCHED TROWELS (6X8)</b>	66972	1/4" 6 mm	3/8" 8 mm	1
<b>TECH-FLEX NOTCHED TROWELS (8X10)</b>	66973	3/8" 8 mm	3/8" 10 mm	
<b>TECH-FLEX NOTCHED TROWELS (10X12)</b>	66974	3/8" 10 mm	1/2" 12 mm	







**▲ CATEGORY: SUPERPRO**      **CLOSED HANDLE**      **WOODEN**



**TROWELS & NOTCHED TROWELS CLOSED WOOD HANDLE**

- Steel plate special high wear resistance with corrosion protection by clear coat. (STEEL).
- Stainless steel plate special high wear resistance (INOX).

	REF.					
STEEL TROWEL 12" (30 CM.)	65950					624
INOX TROWEL 12" (30 CM.)	65960	- - mm	- - mm			480
SHARP EDGED INOX TROWEL 12" (30 CM.)	74948					-
STEEL NOTCHED TROWEL 11" (28 CM.) 1/8" X 1/8" (3 X 3 MM.)	65989	1/8" 3 mm	1/8" 3 mm	- - mm	6	624
STEEL NOTCHED TROWEL 11" (28 CM.) 1/4" X 1/4" (6 X 6 MM.)	65982	1/4" 6 mm	1/4" 6 mm			
STEEL NOTCHED TROWEL 11" (28 CM.) 3/8" X 3/8" (8 X 8 MM.)	65984	3/8" 8 mm	3/8" 8 mm			
STEEL NOTCHED TROWEL 11" (28 CM.) 13/32" X 13/32" (10 X 10 MM.)	65985	3/8" 10 mm	3/8" 10 mm			
STEEL NOTCHED TROWEL 11" (28 CM.) 1/2" X 1/2" (12 X 12 MM.)	74947	1/2" 12 mm	1/2" 12 mm			-

**▲ CATEGORY: PRO**      **WOODEN**



**SPATULAS & NOTCHED SPATULAS WOOD HANDLE**

- 7" (18 cm) wide plate. Special steel high wear resistance.

	REF.				
STEEL NOTCHED SPATULA 7" (18 CM.) 1/8"X1/8"(3X3 MM.)	71923	1/8" 3 mm	1/8" 3 mm	12	3456
STEEL NOTCHED SPATULA 7" (18 CM.) 1/4"X1/4" (6X6 MM.)	71924	1/4" 6 mm	1/4" 6 mm		
STEEL NOTCHED SPATULA 7" (18 CM.) 5/16"X5/16"(8X8 MM.)	71925	3/8" 8 mm	3/8" 8 mm		
STEEL NOTCHED SPATULA 7" (18 CM.) 3/8"X3/8"(10X10 MM.)	71926	3/8" 10 mm	3/8" 10 mm		

 CATEGORY: SUPERPRO



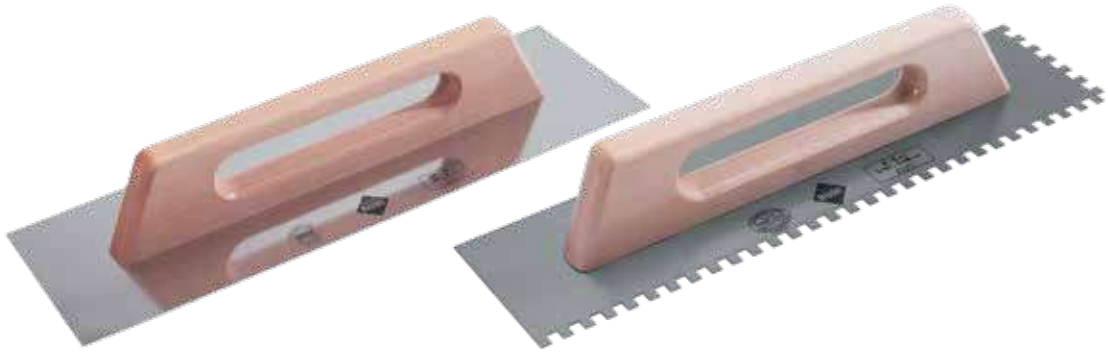

CLOSED HANDLE

WOODEN



### 19" (48 CM) TROWELS & NOTCHED T. CLOSED WOOD HANDLE

- Steel plate special high wear resistance, corrosion-protected by clear coat (STEEL).
- Stainless steel plate special high wear resistance (INOX)
- Perfect flatness of the plate.
- The notches 13/16" x 13/16" (20 x 20 mm.) developed for dosing of glue mortar on uneven floors. Allows more material thickness.

	REF.					
STEEL TROWEL 19" (48 CM.)	65988	-"	-"	-	6	360
INOX TROWEL 19" (48 CM.)	72915	- mm	- mm			
STEEL NOTCHED TROWEL 19" (48 CM.) 1/4" X 1/4" (6 X 6 MM.)	65958	1/4"	1/4"			
STEEL NOTCHED TROWEL 19" (48 CM.) 3/8" X 3/8" (8 X 8 MM.)	65959	3/8"	3/8"			
STEEL NOTCHED TROWEL 19" (48 CM.) 13/32" X 13/32" (10 X 10 MM.)	65983	10 mm	10 mm			
STEEL NOTCHED TROWEL 19" (48 CM.) 1/2" X 1/2" (12 X 12 MM.)	73973	1/2"	1/2"			
STEEL NOTCHED TROWEL 19" (48 CM.) 13/16" X 13/16" (20 X 20 MM.)	75962	3/4"	3/4"			

 CATEGORY: SUPERPRO

### LEVELLING TROWELS

- Levelling trowels wood handle.
- Special high wear resistant steel plate.
- Plate measures: 15 3/4" x 4 11/32" (40 x 11 cm).

	REF.		
LEVELLING TROWEL POINTED TIP	60997	2	288



**CATEGORY: SUPERPRO**      **CLOSED HANDLE**      **RUBIFLEX**



**TROWELS & NOTCHED T. CLOSED RUBIFLEX HANDLE**

- Steel plate special high wear resistance with corrosion protection by clear coat (STEEL).
- Stainless steel plate high wear resistance (INOX).
- Ergonomic RUBIFLEX handle with two textures.
- Perfect flatness of the plate.

	REF.					
STEEL TROWEL-12" (30 CM.)	75950	-"	-"			
INOX TROWEL 12" (30 CM.)	75970	- mm	- mm			
STEEL NOTCHED TROWEL 11" (28 CM.) 1/4"X1/4" (6X6 MM.)	75955	1/4" 6 mm	1/4" 6 mm	-" - mm	6	624
STEEL NOTCHED TROWEL 11" (28CM) 3/8"X3/8" (8X8 MM.)	75957	3/8" 8 mm	3/8" 8 mm			
STEEL NOTCHED TROWEL 11" (28CM) 1/2"X1/2" (10X10 MM.)	75958	3/8" 10 mm	3/8" 10 mm			
STEEL NOTCHED TROWEL 11" ( 28 CM.) 1/2"X1/2" (12X12 MM.)	75959	1/2" 12 mm	1/2" 12 mm			264

**CATEGORY: SUPERPRO**      **OPEN HANDLE**      **RUBIFLEX**



**45° NOTCHED TROWEL RUBIFLEX OPEN HANDLE**

- 45° Angled notches for comfort and less user effort.
- Improves adherence of the mortar on to work surface.
- Special carbon steel alloy plate of high wear resistance.
- Extremely light, high resistance aluminium reinforcement.
- Highly rigid joint between the reinforcement and the plate.
- Ergonomic RUBIFLEX handle with two textures.
- Clear coat for protection against corrosion.
- Perfect flatness of the plate.

	REF.					
45° NOTCHED TROWEL 11" (28 CM) 1/4"X1/4" (6X6)	75946	1/4" 6 mm	1/4" 6 mm	-" - mm	6	480
45° NOTCHED TROWEL 11" (28 CM) 3/8"X3/8" (8X8)	75947	3/8" 8 mm	3/8" 8 mm			
45° NOTCHED TROWEL 11" (28 CM) 13/32"X13/32" (10X10)	75948	3/8" 10 mm	3/8" 10 mm			
45° NOTCHED TROWEL 11" (28 CM) 1/2"X1/2" (12X12)	75923	1/2" 12 mm	1/2" 12 mm			
45° NOTCHED TROWEL 11" (28 CM) R-13/32" (10 MM.)	75924	-" - mm	-" - mm	3/8" 10 mm		

 CATEGORY: SUPERPRO

OPEN HANDLE

RUBIFLEX

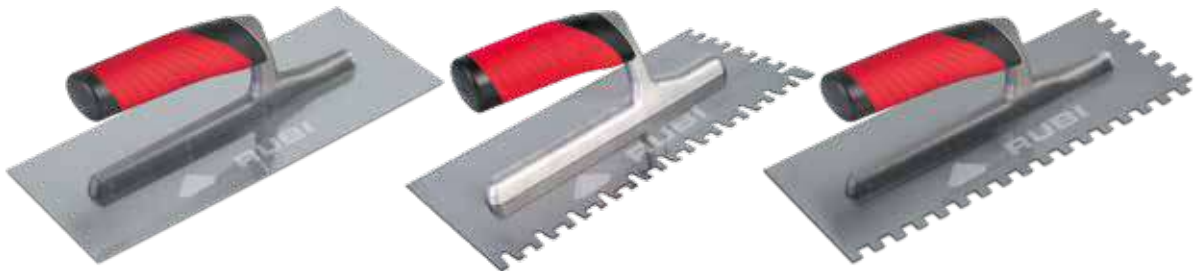

## TROWELS & NOTCHED TROWELS OPEN RUBIFLEX HANDLE

- Extremely light and resistant aluminium core.
- The connection between core and plate is very rigid.
- Highly wear-resistant special steel sheet with protection against corrosion by means of colourless varnish (STEEL).
- Special stainless steel sheet with high wear resistance (SS).
- RUBIFLEX ergonomic handle with two textures.
- Perfect blade flatness.
- YW notched trowel (Ref.77923), with a distinctive and unique shape of notches (not rectangular) to achieve optimal wetting (near 100%) of the tile with the adhesive. Specially created for tiles for which wetting is key (large tiles), and works very well with large format and SLAB type tiles.

	REF.					
INOX TROWEL 11" (28 CM.)	72919	-"	-"			
STEEL NOTCHED TROWEL 1/8"X1/8" (3X3 MM.)	72906	1/8"	1/8"			
INOX NOTCHED TROWEL 11" (28 CM.) 1/8"X1/8" (3X3 MM.)	74936	3 mm	3 mm			
STEEL NOTCHED TROWEL 11" (28 CM.) 3/16"X3/16" (4.5X4.5 MM.)	74980	1/8"	1/8"			
INOX NOTCHED TROWEL 11" (28 CM.) 3/16"X3/16" (4.5X4.5 MM.)	74937	4,5 mm	4,5 mm			
STEEL NOTCHED TROWEL 11" (28 CM.) 1/4"X1/4" (6X6 MM.)	72907	1/4"	1/4"			270
INOX NOTCHED TROWEL 11" (28 CM.) 1/4"X1/4" (6X6 MM.)	74938	6 mm	6 mm	-"		
STEEL NOTCHED TROWEL 11" (28 CM.) 3/8"X3/8" (8X8 MM.)	72908	3/8"	3/8"	- mm		
INOX NOTCHED TROWEL 11" (28 CM.) 3/8"X3/8" (8X8 MM.)	74940	8 mm	8 mm		6	
STEEL NOTCHED TROWEL 11" (28 CM.) 13/32"X13/32" (10X10 MM.)	72909	3/8"	3/8"			
INOX NOTCHED TROWEL 11" (28 CM.) 13/32"X13/32" (10X10 MM.)	74941	10 mm	10 mm			
STEEL NOTCHED TROWEL 11" (28 CM.) 1/2"X1/2" (12X12 MM.)	74982	1/2"	1/2"			288
INOX NOTCHED TROWEL 11" (28 CM.) 1/2"X1/2" (12X12 MM.)	74942	12 mm	12 mm			270
INOX NOTCHED TROWEL 11" (28 CM.) 9/16"X9/16" (15X15 MM.)	76947	5/8"	5/8"			-
STEEL NOTCHED TROWEL 11" (28 CM.) R-13/32" (10 MM.)	72910	-"	-"	3/8"		270
		- mm	- mm	10 mm		
STEEL NOTCHED TROWEL 28 CM. YW	77923	1/4"1/2"	3/8"1/4"	-"		-
		6 / 12 mm	8 / 7 mm	- mm		



▲ CATEGORY: PRO

CLOSED HANDLE

PLASTIC



### TROWELS & NOTCHED TROWELS CLOSED PLASTIC HANDLE

- Steel plate special high wear resistance with corrosion protection by clear coat.

	REF.					
STEEL TROWEL 12" (30 CM.)	65951	-"	-"			624
NOTCHED TROWEL 11" (28 CM.) 1/4" X 1/4" (6X6 MM.)	65966	1/4"	1/4"		6	480
NOTCHED TROWEL 11" (28 CM.) 3/8" X 3/8" (8X8MM.)	65967	3/8"	3/8"	-"		
		6 mm	6 mm	- mm		
NOTCHED TROWEL 11" (28 CM.) 13/32" X 13/32" (10X10 MM.)	65968	3/8"	3/8"			
		10 mm	10 mm			

▲ CATEGORY: PRO

OPEN HANDLE

PLASTIC

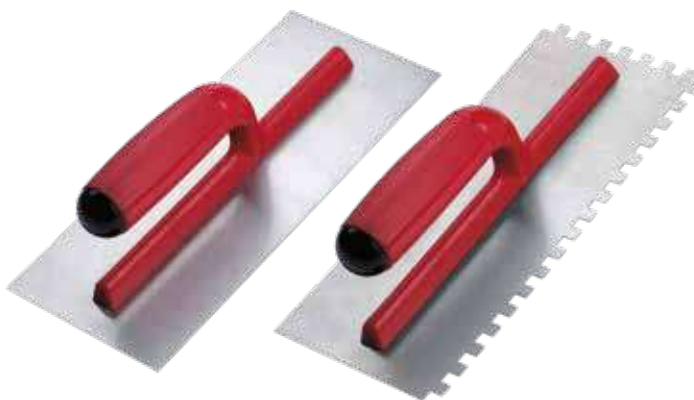

### TROWELS OPEN PLASTIC HANDLE

- Steel plate. Special high wear resistance.
- Plate trowel: 11" x 4" (28 x 12 cm).
- Plate notched trowel: 11" x 4" (28 x 12 cm).

	REF.					
STEEL TROWEL 11" (28 CM.) OPEN PLASTIC HANDLE	25900	-"	-"			
STEEL NOTCHED TROWEL 11" (28 CM.) 1/8" X 1/8" (3 X 3 MM.)	25901	1/8"	1/8"		6	720
STEEL NOTCHED TROWEL 11" (28 CM.) 3/16" X 3/16" (4,5 X 4,5 MM.)	25902	3 mm	3 mm			
		1/8"	1/8"			
		4,5 mm	4,5 mm			
STEEL NOTCHED TROWEL 11" (28 CM.) 1/4" X 1/4" (6 X 6 MM.)	25903	1/4"	1/4"	-"		
		6 mm	6 mm	- mm		
STEEL NOTCHED TROWEL 11" (28 CM.) 5/16" X 5/16" (8 X 8 MM.)	25905	3/8"	3/8"			
		8 mm	8 mm			
STEEL NOTCHED TROWEL 11" (28 CM.) 3/8" X 3/8" (10 X 10 MM.)	25906	3/8"	3/8"			
		10 mm	10 mm			
STEEL NOTCHED TROWEL 11" (28 CM.) 1/2" X 1/2" (12 X 12 MM.)	25907	1/2"	1/2"			
		12 mm	12 mm			

## RUBI TROWELS & BRICK TROWEL RANGE

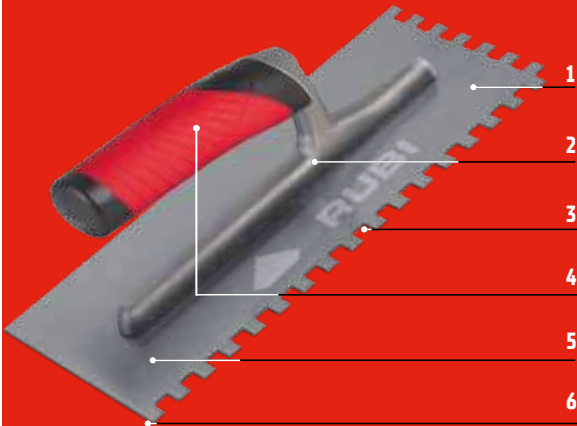

Extremely light and resistance aluminium reinforcement.

Highly rigid fixation between the reinforcement and the plate.

Steel/stainless steel plate with high resistance to abrasion.

Ergonomic RUBIFLEX handle with two textures.

Corrosion protection with clear varnish.

Perfect flatness of the plate.

- 1 Special white nylon lap for tapping without staining.
- 2 Wooden handle in varnished beech.
- 3 Nickel-plated notched ring to increase handle fixation.
- 4 Solid, non-detachable mounting between handle and pin.
- 5 Fusion technique to forging temperature. Fully guaranteed for life against breakage.
- 6 Perfect flatness of the entire plate.
- 7 Plate protected against corrosion.
- 8 Fibres oriented lengthwise during plating.  
Specific thermal treatment on:
  - Plate, to improve flexibility and prevent wear-off.
  - Pin, to improve hardness and rigidity.
- 9 Maximum lightness retaining its resistance.
- 10 Total regularity of all fabrications.
- 11 Perfect adaptation of shapes, sizes and specific characteristics of each market demands.

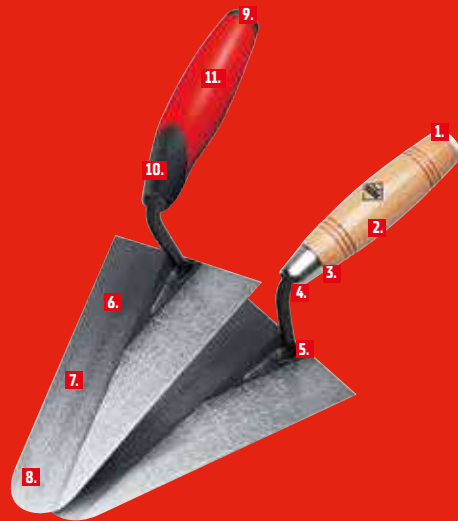

## PALETTE LENGTH BY COLOUR

	S	M	L	XL
	50-99 mm 1 1/8"-3 3/8"	100-129 mm 3 15/16"-5 1/16"	130-169 mm 5 1/8"-6 5/8"	170-200 mm 6 1/16"-7 7/8"

## BRICK TROWELS

- PERFECT ADAPTION IN SHAPES, SIZES AND SPECIFIC CHARACTERISTICS MEETING THE DEMANDS OF EACH MARKET.



◇ CATEGORY:  
SUPERPRO



## PFP01

- Ergonomic RUBIFLEX.

	REF.				
PFP01-120 MM. [4 3/4"]	75012	4 3/4" 120 mm	2 7/8" 73 mm	0.33069 lb 0,150 kg	6
PFP01-140 MM. [5 1/2"]	75014	5 1/2" 140 mm	2" 75 mm	0.3483268 lb 0,158 kg	

◇ CATEGORY:  
SUPERPRO



## PFP05

- Ergonomic RUBIFLEX.

	REF.				
PFP05-180 MM. [7 1/16"]	75418	7 1/8" 180 mm	4 1/8" 105 mm	0.628311 lb 0,285 kg	6
PFP05-200 MM. [7 7/8"]	75420	7 7/8" 200 mm	4 3/8" 110 mm	0.7032674 lb 0,319 kg	

◇ CATEGORY:  
SUPERPRO



## PFM06

- Varnished beechwood handle.

	REF.				
PFM06-200 MM. [7 7/8"]	35520	7 7/8" 200 mm	5 3/8" 137 mm	0.793656 lb 0,360 kg	6

◇ CATEGORY:  
SUPERPRO



## PFP10

- Ergonomic RUBIFLEX.

	REF.				
PFP10-130 MM. [5 1/8"]	75913	5 1/8" 130 mm	2 3/4" 70 mm	0.2777796 lb 0,126 kg	6

◇ CATEGORY:  
SUPERPRO



## PFP19

- Ergonomic RUBIFLEX.

	REF.				
PFP19- 80 MM. [4 5/16"]	76808	4 1/4" 109 mm	3 1/8" 80 mm	0.3350992 lb 0,152 kg	6
PFP19- 90 MM. [5 1/16"]	76809	5 1/8" 128 mm	3 1/2" 90 mm	0.3703728 lb 0,168 kg	







CATEGORY:  
SUPERPRO



### PFM22

• Varnished beechwood handle.





	REF.				
<b>PFM22-165 MM.</b> <b>[6 5/8"]</b>	37116	6 5/8" 168 mm	4 5/8" 119 mm	0.7914514 lb 0.359 kg	6
<b>PFM22-180 MM.</b> <b>[7 1/4"]</b>	37118	7 1/4" 184 mm	4 7/8" 124 mm	0.815702 lb 0.370 kg	

CATEGORY:  
SUPERPRO



### PFP22

• Ergonomic RUBIFLEX handle.





	REF.				
<b>PFP22-165 MM.</b> <b>[6 5/8"]</b>	77116	6 5/8" 168 mm	4 5/8" 119 mm	0.8068836 lb 0.366 kg	6
<b>PFP22-180 MM.</b> <b>[7 1/4"]</b>	77118	7 1/4" 184 mm	4 7/8" 124 mm	0.981047 lb 0.445 kg	

CATEGORY:  
SUPERPRO



### PFM23

• Varnished beechwood handle.





	REF.				
<b>PFM23-180A MM.</b> <b>[7 3/16"]</b>	37258	7 1/4" 183 mm	4 5/8" 117 mm	0.7804284 lb 0.354 kg	6

CATEGORY:  
SUPERPRO



### PFP23

• Ergonomic RUBIFLEX handle.





	REF.				
<b>PFP23-180 A MM.</b> <b>[7 3/16"]</b>	77258	7 1/4" 183 mm	4 5/8" 117 mm	0.7958606 lb 0.361 kg	6
<b>PFP23-185 B MM.</b> <b>[7 1/8"]</b>	77268	7 1/8" 181 mm	5 1/8" 131 mm	0.859794 lb 0.390 kg	

CATEGORY:  
SUPERPRO



### PFM24

• Varnished beechwood handle.

	REF.				
<b>PFM24-140 MM.</b> <b>[5 1/2"]</b>	37314	5 1/2" 140 mm	3 1/4" 82 mm	0.3218716 lb 0.146 kg	6
<b>PFM24-160 MM.</b> <b>[6 5/16"]</b>	37316	6 1/4" 160 mm	3 5/8" 92 mm	0.3350992 lb 0.152 kg	
<b>PFM24-180 MM.</b> <b>[7 1/16"]</b>	37318	7 1/8" 180 mm	4 1/8" 103 mm	0.5643776 lb 0.256 kg	



CATEGORY:  
SUPERPRO



### PFP24

• Ergonomic RUBIFLEX handle.

	REF.				
<b>PFP24-140 MM.</b> <b>[5 1/2"]</b>	77314	5 1/2" 140 mm	3 1/4" 82 mm	0.3395084 lb 0.154 kg	6
<b>PFP24-160 MM.</b> <b>[6 5/16"]</b>	77316	6 1/4" 160 mm	3 5/8" 92 mm	0.3373038 lb 0.153 kg	
<b>PFP24-180 MM.</b> <b>[7 1/16"]</b>	77318	7 1/8" 180 mm	4 1/8" 103 mm	0.5798098 lb 0.263 kg	
<b>PFP24-200 MM.</b> <b>[7 7/8"]</b>	77320	7 7/8" 200 mm	4 3/8" 110 mm	0.606265 lb 0.275 kg	

CATEGORY:  
SUPERPRO



### PFP25

• Ergonomic RUBIFLEX handle.

	REF.				
<b>PFP25-180 MM.</b> <b>[7 1/16"]</b>	77418	7 1/8" 180 mm	4 3/8" 110 mm	0.6679938 lb 0.303 kg	6

CATEGORY:  
SUPERPRO



### PFM26

• Varnished beechwood handle.

	REF.				
<b>PFM26-200 MM.</b> <b>[7 7/8"]</b>	37520	7 7/8" 200 mm	5 1/4" 132 mm	0.815702 lb 0.370 kg	6

CATEGORY:  
SUPERPRO



### PFP33

• Ergonomic RUBIFLEX handle.

	REF.				
<b>PFP33-170X50 MM.</b> <b>[6 11/16" X 1 15/16"]</b>	79050	6 3/4" 170 mm	1" 50 mm	0.3395084 lb 0.154 kg	6

CATEGORY:  
SUPERPRO



### PFM55

• Special for tile installers, sharp arrow.  
• Varnished beechwood handle.

	REF.				
<b>PFM55-165 MM.</b> <b>[6 1/2"]</b>	38416	6 1/2" 165 mm	4 1/2" 114 mm	0.617288 lb 0.280 kg	6

# FLOATS

## • PLASTER FLOATS

**1**  
Prepare

▲ CATEGORY:  
SUPERPRO



### RETICULATED POLYETHYLENE FLOATS

- For finish floating mortar plastering.
- Maximum lightness and resistance to wear off.
- Very low water absorption. Guarantees dimensional stability.



	REF.	
POINT TIP POREX TROWEL 8 7/8" X 5 1/2" [24 X 14 CM.]	83998	10
RECTANGULAR POREX TROWEL 8 7/8" X 5 1/2" [24 X 14 CM.]	83999	

▲ CATEGORY:  
PRO



### POREX FLOATS

- For plastering walls.
- Density and hardness permits an even finish.



	REF.		
POINT TIP POREX TROWEL 9 1/2" X 5" [24 X 14 CM.]	83993	10	240
RECTANGULAR POREX TROWEL 9 1/2" X 5" [24 X 14 CM.]	83992		

▲ CATEGORY:  
PRO



### ROUGH PLASTIC HANDLE FLOATS

- Reinforced plate of high resistance to abrasion and long durability.
- Perfectly flat base.

	REF.		
POINT TIP FLOAT 10 X 5" [27 X 14 CM.]	71941	10	360
RECTANGULAR FLOAT 10" X 7" [27 X 18 CM.]	71943		240
RECTANGULAR FLOAT 13" X 9" [34 X 23 CM.]	71944		180



# RUBBER GROUT FLOATS

- RUBBER FLOATS FOR GROUTING, WITH ERGONOMIC OR WOODEN HANDLES.
- AVAILABLE IN DIFFERENT RUBBER TO OBTAIN THE BEST FINISHING ACCORDING TO THE JOINT WIDTH.

**4**  
Grout

◇ CATEGORY:  
SUPERPRO



## GROUT FLOATS SUPERPRO WOOD

- Wood ergonomic handle.
- Available in different hardnesses of rubber for best finish as the joint width.
- Rubber float trowel, with white rubber sheet wear resistant.
- Solid rubber float, with hard rubber abrasion resistant. Thermoflex float, medium hardness.

	REF.		
RUBBER GROUT FLOAT SUPERPRO	65970		
THERMOFLEX RUBBER GROUT FLOAT SUPERPRO	65976	6	540
SOLID RUBBER GROUT FLOAT SUPERPRO	65975		

◇ CATEGORY:  
SUPERPRO



## GROUT FLOATS SUPERPRO PLASTIC

- Plastic ergonomic handle.
- Available in different hardnesses of rubber for best finish as the joint width.
- Rubber float trowel, with white rubber sheet wear resistant.
- Solid rubber float, with hard rubber abrasion resistant. Thermoflex float, medium hardness.

	REF.		
RUBBER GROUT FLOAT SUPERPRO	65971		
THERMOFLEX RUBBER GROUT FLOAT SUPERPRO	65973	6	540
SOLID RUBBER GROUT FLOAT SUPERPRO	65972		

◇ CATEGORY:  
PRO



## GROUT FLOATS PRO

- Black foam rubber.
- Grout Float PRO 9"x4" 22.5x10cm. (Ref.10607), with white rubber sheet wear resistant.

	REF.		
RUBBER GROUT FLOAT 9"x4"X19/32" [22,5X10X1,5CM]	10607	6	384
GROUT FLOAT PRO 9 1/2"x4 3/4"X13/32" [24X12X1CM]	24968	10	
GROUT FLOAT PRO 11"x5"X13/32" [28X14X1CM]	24969		-

◇ CATEGORY:  
PRO



## REPLACEABLE GROUT FLOAT PRO

- Grout Float (Ref.84924) with sheet resistant to abrasion.
- Replaceable with spare (ref. 84925).

	REF.	
REPLACEABLE GROUT FLOAT PRO	84924	6
SPARE GROUT FLOAT PRO	84925	15

## FLOATS FOR PLASTER

• TROWELS FOR THE CORRECT APPLICATION AND SMOOTHING OF PLASTER.

1  
Prepare

▲ CATEGORY:  
PRO



### PLASTER FLOATS

• Flexible polyethylene and nonstick base.

	REF.	
PLASTIC HANDLE FLOAT 12" X 5" (30 X 14 CM.)	71904	6

▲ CATEGORY:  
SUPERPRO



### FLEXIBLE PLASTER FLOATS

• For multi finish and skimming plaster jobs (also compatible with microcement).  
• Ideal for vertical jobs in heights.  
• 1.2 mm thick polypropylene (PP) plate.

	REF.	
FLEXIBLE FINE PLASTIC HANDLE FLOAT	72824	6

## SPATULAS

• GREAT VARIETY OF SPATULAS FOR MULTIPLE PURPOSES.

4  
Grout

▲ CATEGORY:  
PRO



### WALL TILE GROUT SPATULA

• For filling joints.

	REF.	
WALL TILE GROUT SPATULA 13" (35 CM.)	65935	1
WALL TILE GROUT SPATULA 7" (18 CM.)	65954	

▲ CATEGORY:  
SUPERPRO



### FLOOR TILE GROUT SPATULA

• Reinforced spatula for professional jobs. Replaceable strip that can be used on both sides.  
• Includes grip and aluminium holder.

	REF.	
FLOOR TILE GROUT SPATULA 24" (60 CM.)	70905	1

**CATEGORY:**  
PRO



### GENERAL PURPOSE SPATULA

• Adaptable to WOODEN HANDLE( Ref. 65450 ) Not included.

	REF.	
GENERAL PURPOSE SPATULA 17" [44 CM.]	65919	1
GENERAL PURPOSE SPATULA 24" [60 CM.]	70902	

**CATEGORY:**  
SÚPERPRO



### ALUMINIUM HANDLE

• Adaptable to floor tile grout spatula 50, 60 and 75 cm.

	REF.	
ALUMINIUM HANDLE	70904	1

**CATEGORY:**  
PRO



### WOODEN HANDLE

• Holder for general purpose spatula of 44cm Ref.65919 and 60cm Ref.70902.

	REF.	
WOODEN HANDLE	65450	1

**CATEGORY:**  
SÚPERPRO



### STAINLESS STEEL PAINT SPATULA RUBIFLEX HANDLE

• Stainless steel plate with ergonomic RUBIFLEX handle.

	REF.	
STAINLESS STEEL PAINT SPATULA 1" 5/8 [40 MM.]	73909	10
STAINLESS STEEL PAINT SPATULA 2" 1/2 [63 MM.]	73914	
STAINLESS STEEL PAINT SPATULA 3" [75 MM.]	73911	
STAINLESS STEEL PAINT SPATULA 4" [100 MM.]	73912	
STAINLESS STEEL PAINT SPATULA 6" [150 MM.]	73913	

# SCRAPERS

## • MORTAR SCRAPERS, SINGLE LAYER, JOINTS AND PLASTER.

**1**  
 Prepare

 CATEGORY:  
 SUPERPRO

### FACADE MORTAR SCRAPER 16" X 2 7/8" (50X72MM)

- Facade mortar scraper with wooden handle.
- Plate dimensions: 6x2 7/8" (150x72mm).

	REF.	
WOODEN HANDLE SCRAPER 6X2" 7/8 (150X72 MM.)	65963	6

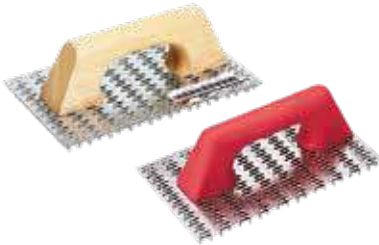
 CATEGORY:  
 SUPERPRO

### FACADE MORTAR SCRAPER 10" X 5 3/4" (250X144MM)

- Facade mortar scraper with two types of handles: Wood and plastic.
- plate dimensions 10" x 5 3/4" (250x144mm).

	REF.		
WOODEN HANDLE SCRAPER 10" X 5 3/4" (250X144 MM.)	72960	6	480
SPARE SCRAPER 10" X 5 3/4" (250X144 MM.)	65957	18	-
PLASTIC HANDLE SCRAPER 10" X 5 3/4" (250X144 MM.)	65962	6	480

 CATEGORY:  
 SUPERPRO

### ALUMINIUM PLASTER SCRAPER

- Manufactured with aluminium, with 8 blades.
- Dimensions 18" x 3 13/32" (455 x 86 mm).

	REF.		
ALUMINIUM PLASTER SCRAPER	72961	1.98414 lb 0,9 kg	1

 CATEGORY:  
 PRO

### JOINT SCRAPER

- Ergonomic handle with two electroplated tungsten carbide plates with high resistance to abrasion.
- Useable with 1, 2 or 3 plates depending on width of the joint.
- Supplied in blister.

	REF.		
JOINT SCRAPER	65907	5	600
SPARE JOINT SCRAPER	71974	10	4600

# RUBISCRAPER-250

## ELECTRIC GROUT SCRAPER

For grout removal without damaging the tile.



  
CATEGORY: SUPERPRO

  
EASY HANDLING

IDEAL SMALL REFORMS

GOOD FINISH

**W**  
250 W



PATENTED

CE

- **Ergonomic design and bi-material finishing, for greater comfort and better stability.**
- **Light and resistant. Maximum reliability.**
- **Blades made in tungsten carbide. Resharpenable for a greater performance. Patented model.**
- **Fast locking / unlocking system for easy assembly of blade.**
- Ideal for repair work (replacement of broken tiles).
- Equipped with 3 speeds. V1: 6500 i.p. / V2: 8000 i.p. / V3: 9500 i.p.
- Power: 250 W.
- Stroke length: 2 mm.
- Double insulation.
- Blades for joints of 1.5 mm (ref. 66810, use only with speed 1) and 3 mm (ref. 66812) included.
- Includes 2 special blades (steel made) to remove rests of thin-set from the back of the tiles or on the substrate.
- With transport case.
- Interchangeable blades for 1.5, 2.3 and 4 mm joints.





	REF.		W	
RUBISCRAPER-250	66940	230V-50Hz	250 250 W	1
RUBISCRAPER-250 UK	66941			
RUBISCRAPER-250 USA	66942	120V-60Hz		

**ACCESSORIES**



RUBISCRAPER Blades





◇ CATEGORY: SUPERPRO



PATENTED

### RUBISCRAPER BLADES

- Resharpenable and easily interchangeable blades, available for 1.5mm (use only with speed 1), 2mm, 3mm and 4mm grout sizes.

	REF.	
1.5 MM (1/16") BLADE FOR RUBISCRAPER	66810	1
2 MM (3/32") BLADE FOR RUBISCRAPER	66811	
3 MM (1/8") BLADE FOR RUBISCRAPER	66812	
4 MM (5/32") BLADE FOR RUBISCRAPER	66813	

## MARKERS, SUPPORTS AND TEMPLATES

- WIDE RANGE OF MARKERS, SUPPORTS AND TEMPLATES FOR THE PLACEMENT OF TILES.



◇ CATEGORY: SUPERPRO



### RULE SUPPORT SET

- For easy adjustment and levelling of the rule for wall tiling.
- In box of 2 units.

	REF.		
RULE SUPPORT SET 12" (30 CM.)	60991	1	207
RULE SUPPORT SET 20" (50 CM.)	60998		

◇ CATEGORY: SUPERPRO



### RULE HOLDER NAILS

- Hold firmly the rulers on the walls, allowing a comfortable placement of tiles.

	REF.	
RULE HOLDER NAIL 10" (250 MM.)	72941	6

◇ CATEGORY: SUPERPRO



### SHAPE TEMPLATE

- Copies the shape of the areas which are awkward to mark onto tiles, for subsequent cutting. Maximum depth 4.5cm.

	REF.	
SHAPE TEMPLATE	70925	10

**CATEGORY:  
SUPERPRO**



### HOLE MARKER

- For marking the position of holes for tubing and electrical fitting, from the wall to the tile, for subsequent cutting or drilling.
- Maximum length 26" ( 65cm).

	REF.	
HOLE MARKER XL	72953	6

**CATEGORY:  
SUPERPRO**



### MASTER LINE MARKER

- Ideal system to quickly draw straight lines between two points of the wall or floor.
- Supplied with a bottle of high quality powder for line marker.

	REF.	
MASTER LINE MARKER	70928	6

**CATEGORY:  
SUPERPRO**



### "MASTER-N" LINE MARKER

- Ideal system to quickly draw straight lines between two points of the wall or floor.
- Supplied with a bottle of high quality powder for line marker.
- Manufactured in plastic bimaterial ( RUBIFLEX ) high resistance to impact.
- Includes auxiliary level for levelling rope before tagging.
- Length of rope: 30 m.

	REF.	
"MASTER-N" LINE MARKER	75925	6

**CATEGORY:  
SUPERPRO**



### STANDARD LINE MARKER

- Ideal system to quickly draw straight lines between two points of the wall or floor.
- Supplied with a bottle of high quality powder for line marking.
- Length of rope: 15m.

	REF.	
LINE MARKER W/TRACING POWDER	70926	6

**CATEGORY:  
SUPERPRO**



### HIGH QUALITY BLUE POWDER FOR LINE MARKER

- Blue powder for filling the line marker.

	REF.	
SPARE BLUE POWDER FOR LINE MARKER 2.2 LB. [1 KG.]	70929	6



CATEGORY:  
SUPERPRO



### CONSTRUCTION PENCIL

- Specially designed for writing on wet or glazed surfaces like ceramic tile, marble, granite, etc.
- Set of 2 construction pencils supplied in blister.

	REF.		
CONSTRUCTION PENCIL	65942	50	450

CATEGORY:  
SUPERPRO



### LINE REEL

- High resistance polyester cord.

	REF.	
LINE REEL Ø 3/8X164 FT. (1.7 MM. X 50 M)	80933	12

## MALLETS

- MALLETS FOR LEVELLING THE HEIGHT OF THE TILES THROUGH OUT INSTALLATION.



CATEGORY:  
SUPERPRO



### RUBBER Mallet - 2 FLAT SIDES

- Allows to strike at any angle so as to install the tile into its correct position.

	REF.		
BLACK RUBBER Mallet 8.8 OZ. (250 GR.)	65904	6	336
BLACK RUBBER Mallet 17.6 OZ. (500 GR.)	65905		
BLACK RUBBER Mallet 26.4 OZ. (750 GR.)	65908		252

CATEGORY:  
SUPERPRO



### RUBBER Mallet - FLAT/SPHERICAL SIDES

- Allows to strike at any angle. One flat surface and the other spherical.

	REF.		
WHITE RUBBER Mallet 8.8 OZ. (250 GR.)	66905	6	336
WHITE RUBBER Mallet 17.6 OZ. (500 GR.)	66906		
WHITE RUBBER Mallet 26.4 OZ. (750 GR.)	66907		252

CATEGORY:  
SUPERPRO



### SOFT BLACK RUBBER Mallet

- A softer mace to protect the ceramic pieces.

	REF.	
SOFT BLACK RUBBER Mallet 17.6 OZ. (500 GR.)	88555	50
SOFT BLACK RUBBER Mallet 26.4 OZ. (750 GR.)	88553	40

# SUCTION CUPS

- SUCTION CUPS TO FACILITATE THE HANDLING OF CERAMICS AND OTHER SMOOTH MATERIALS.

**3**  
Set

 CATEGORY:  
PRO

## SINGLE SUCTION CUP

- Maximum load capacity: 88 Lb (40 kg).

	REF.	
SINGLE SUCTION CUP	65900	1

 CATEGORY:  
PRO

## DOUBLE SUCTION CUP



- Body made of highly resistant aluminium. With ergonomic handle for greater comfort.
- Maximum load capacity : 176,4LB (80 kgs).

	REF.	
DOUBLE SUCTION CUP	66900	1

 CATEGORY:  
PRO

## TRIPLE SUCTION CUP

- Body made of highly resistant aluminium. With ergonomic handle for greater comfort.
- Maximum load of capacity: 220lbs ( 100 kg ).

	REF.		
TRIPLE SUCTION CUP	66904	1	80

 CATEGORY:  
SUPERPRO

ROUGH



## RM ROUGH SURFACE SUCTION CUP

- Suction cups for handling tiles with rough and/or slightly structured surfaces.
- Injected polycarbonate body. Very light.
- Metal reinforcement in the lever base for greater tensile strength.
- Ergonomic polypropylene handle for faster, safer handling.
- Natural rubber.
- Maximum load capacity:55 lb (25 kg).
- Suction cup diameter: 4 3/4" (120 mm).

	REF.		
RM ROUGH SURFACE SUCTION CUPS	66929	1	280

 CATEGORY:  
SUPERPRO

ROUGH



## RM ROUGH SURFACE DOUBLE SUCTION CUP

- Double suction cup for handling tiles with rough and/or slightly structured surfaces.
- Body made of highly resistant aluminium.
- Metal reinforcement in the lever base for greater tensile strength.
- Ergonomic polypropylene handle for faster, safer handling.
- Natural rubber.
- Maximum load capacity: 55 kg.
- Suction cup diameter: 120 mm.

	REF.		
RM ROUGH SURFACE DOUBLE SUCTION CUP	66952	1	96

# OCTO-USB ENERGY

## SAFE & EASY TO USE

Suction cup to lift ceramic tiles with smooth or slightly textured and clean surfaces.







CATEGORY: PRO

USE: PROFESSIONAL

SECURITY  
140 kg

USB BATTERY

- Battery suction cup designed for handling ceramic tiles.
- 3.7V / 2 Ah. battery integrated in the suction cup and charging via USB-C cable. (cable included, charger not included).
- Water and dust proof buttons. IP30.
- Digital display with 4 indicators: Vacuum / Release / ON / Charge + MBAR pressure info screen.
- Max load capacity: 140 kg only for flat & smooth surfaces and horizontal handling.
- Plastic case for transport and protection.

	REF.					
OCTO-USB ENERGY	66967	3.7V / 2Ah	8 5/8" 220 mm	2.667566 lb 1.21 kg	3.3069 lb 1.5 kg	10





**CATEGORY: PREMIUM**

**VACUUM**

**SECURITY 110 kg**

### SC-200 SUCTION CUP WITH VACUUM PUMP

- Suction cup for handling large and heavy tiles.
- Special for textured surfaces.
- Adapts to any surface finish.
- Suction applied by manual vacuum pump.
- Load loss indicator (red mark).
- Pressure-release mechanism.
- Maximum load capacity: 243 lb (110 kg).

	REF.				
SC-200 VACUUM PUMP CUP	18919	7 7/8" 200 mm	3.3069 lb 1,6 kg	8	90



**CATEGORY: PREMIUM**

**VACUUM**

**SECURITY 110 kg**

**NO MARKS**

### GSC-200 VACUUM SUCTION CUP

- Suction cup for the manipulation of large ceramic tiles and heavy porcelain slabs.
- Adapts to the surface without leaving any marks.
- Fixing by vacuum manual pump.
- Load loss indicator (red mark).
- Pressure release mechanism.
- Maximum load capacity: 110 kg.
- High resistance plastic body.
- Transport suitcase.

	REF.				
GSC-200 GREY VACUUM SUCTION	21951	7 7/8" 200 mm	3.3069 lb 1,5 kg	8	90

## TILING ACCESSORIES

**2**  
Cut & Drill

**CATEGORY: SUPERPRO**



### ABRASIVE BLOCK

- Fine and coarse grit.
- Smooths out tiles.

	REF.	
ABRASIVE BLOCK	05972	5

**CATEGORY: PRO**



### GLUE GUN APPLICATOR

- Glue applicator 55 W. High performance.
- 100~240V/50~60Hz.
- Compatible with bars of Ø11 - Ø12mm.
- Universal glue.

	REF.		
GLUE GUN APPLICATOR	65940	6	432
25 GLUE BARS OF 8" [195 MM.]	65946	10	800

## WORK TABLES

3  
Set

CATEGORY: SUPERPRO



## FOLDING 4-IN-1 WORKING TABLE

- 4 uses in 1: Work bench, scaffold, dolly and creeper.
- Foldable, easy to transport and storage.
- Double sided board: MDF wood side (work bench function) and non-slippery PP plastic side (rest of functions). EASY interchangeable.
- Reinforced stainless steel area for harder jobs. Avoids damages on wooden surface.
- Angle conveyor and rule printed on the wooden side. Also includes a hole for small drillings (max. 25 mm) and hand tools inserts on metal frame.
- Folded table: 80x52x12,5cm.
- Unfolded table: 115x52x80cm.

	REF.		
FOLDING 4-IN-1 WORKING TABLE	66924	1	16

CATEGORY: PRO

USE: PROFESSIONAL

TRANSPORTABLE

NEW!



## RETRACTABLE WORKTABLE

- Lightweight retractable structure with high load capacity.
- Easy to transport with wheels and carrying bag.
- Takes up very little space when folded.
- Easy to assemble and disassemble almost instantly, no tools required.
- Deployed dimensions.
- 300 X 120 TABLE: 75 x 300 x 120 cm.
- 120 X 120 TABLE: 75 x 120 x 120 cm.
- Maximum load (depending on final material):
- 300 X 120 TABLE: 1500 kg.
- 120 X 120 TABLE: 700 kg.

	REF.	
RETRACTABLE WORKTABLE 300X120	28917	1
RETRACTABLE WORKTABLE 120X120	28918	



## RUBI LUMEO

1  
Prepare

CATEGORY: PREMIUM

CAS BATTERY COMPATIBLE

NEW!

18V



## COMPATIBILITY

RUBIMIX E-9 ENERGY CAS	18 V 5.2 Ah
RUBIMIX E-10 ENERGY CAS	18 V 5.2 Ah
ANGLE GRINDER TECH	18 V 5.2 Ah
RUBI LUMEO	18 V 5.2 Ah
QUAKE ENERGY CAS	18 V 2.0 Ah
RUBI TRILLER ENERGY CAS	12 V 4.0 Ah

## RUBI LUMEO ENERGY CAS

- Universal battery-operated work light.
- Lightweight and powerful for professional users.
- Extremely robust (IK07) and versatile with 5-level adjustable light output (from 400 to 4000 lumens).
- Stylish design with carrying handle and support for flexible positioning through direct mounting on the TRIPOD accessory.
- Suitable for both indoor and outdoor work (IP67).
- Operates with an 18V CAS battery.
- Includes a small spare battery in case of failure or battery depletion.

REF.



RUBI LUMEO ENERGY CAS

10940

1

CATEGORY:  
PREMIUM

NEW!

## RUBI TRIPOD LUMEO

- The practical design of the TRIPOD makes it an indispensable accessory for the stationary positioning of work lights, especially for illuminating a specific work area.
- Extendable from 1.35 to 3 meters, the tripod offers total flexibility to place the work light at the required height and the option to tilt the mounted light to provide the optimal light angle.
- With its extremely compact design, the tripod is easy and convenient to transport and install wherever necessary.
- Features QUICK RELEASE function and is made of black painted aluminium. The tripod is very durable and can be used both indoors and outdoors.
- Maximum load 10 kg.
- Its robust construction makes it safe even when fully extended.
- Net weight 6 kg.

REF.



RUBI TRIPOD LUMEO

10939

1



## TOOLS BOXES

### • TOOL BOXES FOR THE CONSTRUCTION PROFESSIONAL.

**3**  
Set

**CATEGORY: SUPERPRO**
**TRAY COMPARTMENTS**

#### PLASTIC TOOL BOX

- Light and highly functional tool box. With wheels and handle for transport.
- Comes with 2 holders and 4 fitments for attaching objects using elastic bands.
- Consists of 1 tray with 14 compartments that can be configured to specific needs and 1 inside tray with 4 compartments.
- Capacity 15 GL. ( 55 L ).
- Outer Dimensions: 24" x 14" x 16" (61 x 37 x 42 cm ).
- Inner Dimensions: 20" x 12" x 14" (51 x 31 x 35 cm ).

	REF.		
PLASTIC TOOL BOX	71954	1	8

**CATEGORY: SUPERPRO**

#### PROFESSIONAL TOOL BOX

- Large tool box. With wheels and handles for transport.
- Lid with 2 pockets and 4 hangers to fix objects with rubber bands (Not Included).
- It contains internal tray with 4 compartments.
- Outer Dimensions: 31" x 19" x 20" (80 x 49 x 50 cm).
- Inner Dimensions: 24" x 14" x 16" (62 x 35 x 41 cm).
- Capacity: 25 GL. ( 89 L ).

	REF.		
PROFESSIONAL TOOL BOX	75965	1	4

# MALLETS & HAMMERS

- MALLETS AND HAMMERS OF GREAT QUALITY WITH TWO TYPES OF HANDLES, WOOD AND RUBIFLEX.

**1**  
Prepare

CATEGORY:  
SUPERPRO



## STONING HAMMER WOOD HANDLE

- Special forged Steel head, tempered and hardened.
- SPANISH type head with electrostatic black paint coating and milled hitting ends.
- Varnished, HICKORY wood handle.
- Head's fixation to handle by cylindrical steel wedge and sealed by resin.
- Weight balanced to reduce hand's kickback.

REF.



	REF.	
STONING HAMMER WOOD HANDLE 700 GR.	71896	6

CATEGORY:  
SUPERPRO



## STONING HAMMER SOFTGRIP HANDLE

- Special forged Steel head, tempered and hardened.
- SPANISH type head with electrostatic black paint coating and milled hitting ends.
- PP handle with fibre glass core, optimal for shock absorption. Improves handle's long-life.
- Bi-material SOFTGRIP handle, non-slippery and grooved for a better grip.
- Head's fixation to handle by cylindrical steel wedge and sealed by resin.
- Weight balanced to reduce hand's kickback.

REF.



	REF.	
STONING HAMMER SOFTGRIP HANDLE 700 GR.	71898	6
STONING HAMMER SOFTGRIP HANDLE 1000 GR.	71899	

CATEGORY:  
SUPERPRO



## FRAMER HAMMER RUBIFLEX HANDLE

- Forged, adjusted and tempered steel head of 28.2 oz ( 800gr ). Double placer / remover for nails, one magnetised.
- Ergonomic handle RUBIFLEX: Unbreakable structure with resistant-section fibre-glass nucleus, optimised for shock absorption, increasing the durability of the handle.
- - Security connection between handle and steel head by inverse cone.
- - Grip with elastic slip-proof elastic and surface grooves for maximum hold.

REF.



	REF.	
FRAMER HAMMER 20" (500 MM.)	82986	6

CATEGORY:  
SUPERPRO



## MASONRY PICK

- Made of special tempered steel, highly resistant at breaking point.
- Normalised heat treatment and tempered tip.

REF.



	REF.	
MASON PICK (SPADE/PICK) 18 OZ. (500 GR.)	82980	6

## CHISELS

- WIDE RANGE OF CHISELS, POINT CHISELS AND NIPPERS.



◆ CATEGORY: SUPERPRO



### FLAT CHISELS

- Made of CrVa. alloy steel. Forged, hardened and tempered cutting edge.
- Re grindable.

	REF.	
CHISEL 10" X 29/32" X 17/32" [250 X 23 X 13 MM.]	70916	10
CHISEL 12" X 29/32" X 17/32" [300 X 23 X 13 MM.]	70917	
CHISEL 14" X 29/32" X 17/32" [350 X 23 X 13 MM.]	70918	

◆ CATEGORY: SUPERPRO



### WIDE CHISELS

- To remove tiles on renovation jobs.
- Made of CrVa. alloy steel. Forged, hardened and tempered cutting edge.
- Re grindable.

	REF.	
WIDE CHISEL 10"/2 3/8" X 1 1/32" X 17/32" [250/60X26X13MM]	70924	10

## SHOVELS

- SHOVELS AND SPADES WITH VARNISHED, WOODEN HANDLE AND SPADES HIGHLY RESISTANT AT BREAKING POINT.



◆ CATEGORY: SUPERPRO

"Y" HANDLE

POINTTIPPED SPADE



### WOODEN RING HANDLED POINT-TIPPED SPADE

- Shovel with D finish.
- Handle with " Y " ring shaped plastic.
- Ergonomic grip, varnished eucalyptus.

	REF.		
WOODEN RING HANDLED POINT-TIPPED SPADE	82963	6	36

◆ CATEGORY: SUPERPRO

"T" HANDLE

POINTTIPPED SPADE



### PROP HANDLED POINT-TIPPED SPADE

- Shovel with "D" shape finish.
- Handle T shaped. Varnished wooden handle.

	REF.		
PROP HANDLED POINT-TIPPED SPADE	82964	6	36

◆ CATEGORY: SUPERPRO

"Y" HANDLE

SQUARE SHOVEL



### WOODEN RING HANDLED SQUARE SHOVEL

- Squared shovel with wooden handle "Y" shaped.
- Ergonomic grip. Varnished wooden handle.

	REF.		
WOODEN RING HANDLED SQUARE SHOVEL	82960	6	54

◆ CATEGORY: SUPERPRO

"T" HANDLE

SQUARE SHOVEL



### PROP HANDLED SQUARE SHOVEL

- Squared shovel with wooden handle "T" shaped.
- Varnished wooden handle.

	REF.		
PROP HANDLED SQUARE SHOVEL	82961	6	36

# NIPPERS

• WIDE RANGE OF PLIERS FOR CUTTING CERAMICS, PORCELAIN & GLASS.



◆ CATEGORY:  
SUPERPRO



## CARPENTER'S PINCER

- For general use.
- Supplied in blister.

REF.



	REF.		
CARPENTER'S PINCER 8 3/4" (220 MM.)	71971	5	765

◆ CATEGORY:  
SUPERPRO



## NIPPERS FOR PORCELAIN TILES

- Specially for cutting narrow strips of a maximum of 7/16" (1 cm). Equipped with tungsten carbide GOLD scoring wheels with titanium surface treatment for longer useful life. By means of a gentle turn, the wheels can be repositioned when their vertex starts getting worn. If totally worn, they can be replaced using their corresponding spare piece, Ø 3/4" (18 mm) GOLD spare scoring wheel long-life (Ref.01953).

REF.



	REF.		
NIPPERS FOR PORCELAIN TILES	83942	5	765

◆ CATEGORY:  
SUPERPRO



## NIPPERS FOR CERAMIC TILES

- Tungsten Carbide Edge.
- Ideal for the rectification of straight cut on ceramics.
- Bi-material handle Ergonomic.

REF.



	REF.		
NIPPERS FOR CERAMIC TILES	65926	6	-

◆ CATEGORY:  
SUPERPRO



## NIPPERS FOR GLASS MOSAIC

- Tungsten Carbide Edge.
- Ideal for the rectification of glass mosaic tiles.
- Bi-material handle Ergonomic.

REF.



	REF.		
NIPPERS FOR GLASS MOSAIC	71970	5	-

◆ CATEGORY:  
SUPERPRO



## TILER NIPPERS

- Tungsten Carbide Pliers.
- Ideal for rectification of holes in ceramics.
- Bi-material handle Ergonomic.

REF.



	REF.		
PARROT NIPPERS	65925	5	765

# GROUT MORTAR APPLICATORS

• **JOINT APPLICATOR FOR MORTAR.**

**4**  
Grout

◆ **CATEGORY: SUPERPRO**



## MANUAL GROUT MORTAR APPLICATOR

- Great capacity (650 cc) grout mortar applicator.
- Very light structure made of aluminium.
- It allows an easy, quick and clean application.
- Reduce consumption of grout and after grouting residue.
- Pressure adjustable with trigger.
- Replaceable and adjustable nozzles to the joint width.
- Also usable for the application of silicone and PU rigid and flexible cartridges.
- Quick and clean application.

	REF.	
MANUAL GROUT MORTAR APPLICATOR 650 CC.	65990	1

◆ **CATEGORY: SUPERPRO**



## SET OF SPARE NOZZLES FOR GROUT MORTAR APPLICATOR

- Spare parts adaptable to Electric (Ref. 66915) and Manual (Ref. 65990) applicators.
- Includes screw, piston and 3 nozzles.

	REF.	
SET OF SPARE NOZZLES FOR GROUT MORTAR APPLICATOR	65981	1

◆ **CATEGORY: SUPERPRO**



## SPARE NOZZLES

- Spare parts adaptable to Electric (Ref. 66915) and Manual (Ref. 65990) applicators.
- Includes 6 nozzles.

	REF.	
SPARE NOZZLES FOR GROUT MORTAR APPLICATOR	65980	1



# ACCESSORIES

## FOR TILE FIXING AND FINISHING

---

Measuring systems  
Tile spacers  
Fast levelling systems





# CONSTRUCTION LEVELS

• WIDE RANGE OF LEVELS.



**CATEGORY:**  
PRO

## RUBILEVEL

- Level manufactured in reliable, resistant aluminium.
- Machined base up to measures of 100 cm to ensure constant accuracy.
- Accuracy: 0,5 mm/m three bubbles for checking horizontal, vertical and 45° levels.



	REF.		
RUBILEVEL 16" (40 CM.)	76920	8	2400
RUBILEVEL 24" (60 CM.)	76922		1600
RUBILEVEL 32" (80 CM.)	76923		1120
RUBILEVEL 40" (100 CM.)	76924		252
RUBILEVEL 59" (150 CM.)	76926	2	448
RUBILEVEL 79" (200 CM.)	76927		

**CATEGORY:**  
PRO

## RUBILEVEL MAGNET

- Level manufactured with reliable, resistant aluminium.
- Machined base to ensure consistent accuracy and Neodymium magnets inserted to hold it on metal surfaces.
- Accuracy: 0,5 mm/m.
- Three bubbles for checking horizontal, vertical and 45° levels.



	REF.		
RUBILEVEL MAGNET 20" (50 CM.)	76929	8	1920
RUBILEVEL MAGNET 24" (60 CM.)	76930		608
RUBILEVEL MAGNET 32" (80 CM.)	76931		1120

**CATEGORY:**  
PRO

## RUBILEVEL ANTISHOCK

- Levels manufactured in reliable, resistant aluminium.
- Double machining to ensure a constant precision in the top face and the base.
- Accuracy: 0,5 mm/m.
- Three bubbles for checking horizontal, vertical and 45° levels.
- Double and ergonomic bi-material handle.
- Rubber protector at the ends.
- DUAL view vertical vial for front measurements. Eliminates parallax error.
- MAGNIFIED horizontal vial for the CLEAREST view of the bubble.



	REF.		
RUBILEVEL ANTISHOCK 24" (60 CM.)	76932	8	672
RUBILEVEL ANTISHOCK 32" (80 CM.)	76933		384
RUBILEVEL ANTISHOCK 40" (100 CM.)	76934		392
RUBILEVEL ANTISHOCK 48" (120 CM.)	76935		



CATEGORY:  
SUPERPRO

### RUBILEVEL ALUCAST

- Level manufactured from cast aluminium.
- Machined base to ensure constant accuracy.
- Accuracy: 0,5 mm/m.
- Two bubbles for checking horizontal and vertical.
- DUAL view vertical vial for front measurements. Eliminates parallax error.



	REF.		
RUBILEVEL ALUCAST 24" [60 CM.]	76938	8	1600
RUBILEVEL ALUCAST 32" [80 CM.]	76939		1120

CATEGORY:  
PRO

### WATER LEVEL

- Includes two graduated tanks and 20 metres of hose.
- With caps to maintain the hose correctly filled & ready for the next use.



	REF.	
WATER LEVEL	70965	1

## MEASURING TAPES

- HOMOLOGATED PRECISION MEASURING TAPES. DIFFERENT SIZES DEPENDING ON NEEDS.



CATEGORY:  
SUPERPRO

### RUBIFLEX MEASURING TAPES

- Ergonomic chassis made from plastic and rubber.
- Approved precision measuring tapes: Class II
- Magnetic tape stopper. (only available in mm).



	REF.		
RUBIFLEX MEASURING TAPE 197" X 3/4" [5M X 19MM]	75901	12	864
RUBIFLEX MEASURING TAPE 315" X 1" [8M X 25MM]	75902		576

CATEGORY:  
SUPERPRO

### IRONBLADE MEASURING TAPES

- Metal case with rubber coating to improve grip.
- Approved precision measuring tapes: Class II
- Automatic tape lock. (only available in mm).



	REF.	
IRONBLADE MEASURING TAPE 197" X 3/4" [5M X 19MM]	75904	12
IRONBLADE MEASURING TAPE 197" X 3/4" [5M X 25MM.] DOUBLE MARKING	75909	
IRONBLADE MEASURING TAPE 315" X 3/4" [8M X 25MM]	75905	



# PLUMB BOB, SQUARES

## • PLUMB BOBS.



◆ CATEGORY: SUPERPRO



### PLUMB BOB

- Length of line: 16,4 ft. (5 m).
- Includes wooden dolly.
- Supplied in blister.

	REF.		
PLUMB BOB 21.2 OZ. (600 GR.)	70964	6	480

◆ CATEGORY: SUPERPRO



### SQUARES

- Square 1 5/8" x 13/16" (40x20mm) with high dimensional stability.
- With bichromated treatment.

	REF.	
SQUARE- 24" (60 CM.)	60993	1
SQUARE- 32" (80 CM.)	60994	

# TILE SPACERS

## • TILE SPACERS, " T " SPACERS AND WEDGES FOR THE CORRECT PLACEMENT OF TILES. QUALITY BASE MATERIAL.



◆ CATEGORY: SUPERPRO



### TILE SPACERS 1/32" (1MM)

- For wall & floor tiles with minimum joint.
- Quality base material, without impurities or imperfections.

	REF.		
TILE SPACERS 1/32" (1 MM.) - (8-300 U.)	02911	10	1200
TILE SPACERS 1/32" (1 MM.) - (8-1000 U.)	02030	1	-

◆ CATEGORY: SUPERPRO



### TILE SPACER 1/16" (1.5MM)

- For wall & floor tiles with minimum joint.
- Quality base material, without impurities or imperfections.

	REF.		
TILE SPACERS 1/16" (1.5 MM.) - (8-300 U.)	02912	10	960
TILE SPACERS 1/16" (1.5 MM.) - (8-1.000 U.)	02031	1	-

**CATEGORY:**  
SUPERPRO



### TILE SPACER 3/32" (2MM)

- For wall & floor tiles with minimum joint.
- Quality base material, without impurities or imperfections.

	REF.		
TILE SPACERS 3/32" (2 MM.) - (B-300 U.)	02901	10	1680
TILE SPACERS 3/32" (2 MM.) - (B-1.000 U.)	02000	1	768

**CATEGORY:**  
SUPERPRO

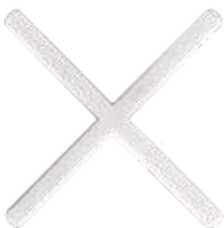

### LONG TILE SPACERS 3/32" (2 MM L)

- For large ceramic format and rectified.
- Quality base material, without impurities or imperfections.

	REF.		
LONG TILE SPACERS 3/32" (2 MM.)-L - (B-300 U.)	02952	10	960
LONG TILE SPACERS 3/32" (2 MM.) -L -(B-1000 U.)	02972	1	378

**CATEGORY:**  
SUPERPRO



### TILE SPACERS 1/8" (3MM)

- For floor tiles with thin joint.
- Quality base material, without impurities or imperfections.

	REF.		
TILE SPACERS 1/8" (3 MM.) -(B-200 U.)	02902	10	1200
TILE SPACERS 1/8" (3 MM.) -(B-1.000 U.)	02001	1	324

**CATEGORY:**  
SUPERPRO



### LONG TILE SPACERS 1/8" (3MM L) "REINFORCED"

- For large ceramic format and rectified.
- Quality base material, free from impurities and imperfections.
- Redesigned internal geometry. High flexural strength and crushing.
- Ideal for large format tiles in walls.

	REF.	
LONG TILE SPACERS 1/8" (3 MM.)-L -(B-200 U.)	02953	10
LONG TILE SPACERS 1/8" (3 MM.)-L -(B-1000 U.)	02973	1

**CATEGORY:**  
SUPERPRO



### TILE SPACER 5/32" (4MM) " REINFORCED "

- For floor tiles.
- Quality base material, free from impurities and imperfections.
- Redesigned internal geometry. High flexural strength and crushing.
- Ideal for large formats.

	REF.		
TILE SPACERS 5/32" (4 MM.) -(B-200 U.)	02954	10	960
TILE SPACERS 5/32" (4 MM.) -(B-1000 U.)	02974	1	216



CATEGORY:  
SUPERPRO



### TILE SPACERS 3/16" (5MM)

- For floor tiles.
- Quality base material, without impurities or imperfections.
- Hollow structure with internal reinforcements. Supports the tensions and allows to leave into the joint and to grout over.

	REF.		
TILE SPACERS 3/16" (5 MM.) -(8-100 U.)	02903	10	960
TILE SPACERS 3/16" (5 MM.)-(8-1.000 U.)	02002	1	-

CATEGORY:  
SUPERPRO



### TILE SPACERS 1/4" (6MM)

- For floor tiles.
- Quality base material, without impurities or imperfections.
- Hollow structure with internal reinforcements. Supports the tensions and allows to leave into the joint and to grout over.

	REF.		
TILE SPACERS 1/4" (6 MM.) - (8-100 U.)	02036	10	540

CATEGORY:  
SUPERPRO



### TILE SPACERS 9/32" (7MM)

- For floor tiles.
- Quality base material, without impurities or imperfections.
- Hollow structure with internal reinforcements. Supports the tensions and allows to leave into the joint and to grout over.

	REF.		
TILE SPACERS 9/32" (7 MM.) -(8-100 U.)	02904	10	540

CATEGORY:  
SUPERPRO



### TILE SPACERS 13/32" (10MM)

- For industrial or rustic tiles.
- Quality base material, without impurities or imperfections.
- Hollow structure with internal reinforcements. Supports the tensions and allows to leave into the joint and to grout over.

	REF.		
TILE SPACERS 13/32" (10 MM.) -(8-50 U.)	02905	10	540

# T FOR JOINTS

**3**  
Set

**CATEGORY:**  
SUPERPRO



## T-SPACERS 3/32" (2MM)

- Ideal for "Brick Bond" and perimeter joints.
- Quality base material without impurities or imperfections.

	REF.	
T-SPACERS 3/32" (2MM) (B-300 UN.)	02861	10
T-SPACERS 3/32" (2MM) (B-1000 UN.)	02864	1

**CATEGORY:**  
SUPERPRO



## T-SPACERS 1/8" (3MM)

- Ideal for "brick style" tiling and perimeters.
- Quality base material, without impurities or imperfections.

	REF.		
T-SPACERS 1/8" (200 PC.) BAG	02923	10	1680
T-SPACERS 1/8" (3 MM.) -(B-1000 U.)	02063	1	540

**CATEGORY:**  
SUPERPRO



## T-SPACERS 3/16" (5MM)

- Ideal for "brick style" tiling and perimeters.
- Quality base material, without impurities or imperfections.
- Hollow structure with internal reinforcements. Supports the tensions and allows to leave into the joint and to grout over.

	REF.	
T-SPACERS 3/16" (100 PC.) BAG	02924	10

**CATEGORY:**  
SUPERPRO



## T-SPACERS 13/32" (10MM.)

- Ideal for "brick style" tiling and perimeters.
- Quality base material, without impurities or imperfections.
- Hollow structure with internal reinforcements. Supports the tensions and allows to leave into the joint and to grout over.

	REF.	
T-SPACERS 13/32" (10 MM.) -(B-50 U.)	02926	10

# WEDGES

**3**  
Set

**CATEGORY:**  
SUPERPRO



## WEDGES

- Wedges for tiling.
- Quality base material, without impurities or imperfections.

	REF.		
WEDGES 3/16" [5MM.] - ( B-250 U.)	02396	10	1600
WEDGES 3/16" [5 MM.]- (B-500 U.)	02950		1500
WEDGES 5/16" [7.5MM.] - ( B-250 U.)	02397		1800
WEDGES 5/16" [7.5 MM.] - (B-500 U.)	02951		960

**CATEGORY:**  
SUPERPRO



## DISPLAY BOX

- Orders by boxes only. Contains bags.

	REF.			
TILE SPACERS 1/32" [1 MM.] - (42 X 300 PC.) DISPLAY BOX	02123	42	300	32
TILE SPACERS 1/16" [1.5 MM.] - (36 X 300 PC.) DISPLAY BOX	02124	36		
TILE SPACERS 3/32" [2 MM.] - (48 X 300 PC.) DISPLAY BOX	02125	48		
TILE SPACERS 1/8" [3 MM.] - (42 X 200 PC.) DISPLAY BOX	02127	42	200	30
TILE SPACERS 3/16" [5 MM.] - (36 X 100 PC.) DISPLAY BOX	02130	36	100	
TILE SPACERS 9/32" [7 MM.] - (16 X 100 PC.) DISPLAY BOX	02132	16	50	32
TILE SPACERS 13/32" [10 MM.] - (18 X 50 PC.) DISPLAY BOX	02135	18		32
WEDGES - 3/16" [5 MM.] - (48 X 500 PC.) DISPLAY BOX	02279	48	500	30



XX





# CONSUMPTION

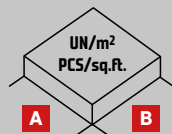

A		inch																inch				
		6	9	12	16	18	20	24	30	32	36	40	48	60	72	80	96		120	128	144	
cm		8	5,3	6	4,5	4	3,6	3	3,2	3	2,7	2,4	2	2	1,7	1,8	1,5	1,4	1,5	1,3	6	
	20	50		3,6	4,0	3,0	2,7	2,4	2,0	2,1	2,0	1,8	1,6	1,3	1,3	1,1	1,2	1,0	0,9	1,0	0,9	9
	25	40	32		4	3	2,7	2,4	2	2	1,9	1,7	1,5	1,3	1,2	1	1,1	0,9	0,8	0,8	0,8	12
	30	50	40	44		2,3	2	1,8	1,5	1,5	1,4	1,3	1,1	0,9	0,9	0,8	0,8	0,7	0,6	0,6	0,6	16
	40	38	30	33	25		1,8	1,6	1,3	1,3	1,3	1,1	1	0,8	0,8	0,7	0,7	0,6	0,5	0,6	0,5	18
	45	33	27	30	22	20		1,4	1,2	1,2	1,1	1	0,9	0,8	0,7	0,6	0,6	0,5	0,5	0,5	0,5	20
	50	30	24	27	20	18	16		1	1	0,9	0,8	0,8	0,6	0,6	0,5	0,5	0,4	0,4	0,4	0,4	24
	60	25	20	22	17	15	13	11		1	0,9	0,8	0,7	0,6	0,6	0,5	0,5	0,4	0,4	0,4	0,3	30
	75	27	21	22	17	15	13	11	11		0,8	0,8	0,7	0,6	0,5	0,4	0,5	0,4	0,3	0,4	0,3	32
	80	25	20	21	16	14	13	10	10	9		0,7	0,6	0,5	0,5	0,4	0,4	0,3	0,3	0,3	0,3	36
	90	22	18	19	14	12	11	9	9	8	7		0,5	0,5	0,4	0,4	0,4	0,3	0,3	0,3	0,3	40
	100	20	16	19	13	11	10	8	8	8	7	6		0,4	0,4	0,3	0,3	0,3	0,2	0,2	0,2	48
	120	17	13	14	10	9	8	7	7	6	6	5	4		0,3	0,3	0,3	0,2	0,2	0,2	0,2	60
	150	17	13	13	10	9	8	7	6	6	5	5	4	4		0,2	0,2	0,2	0,2	0,2	0,2	72
	180	14	11	11	8	7	7	6	5	5	4	4	3	3	2		0,2	0,2	0,2	0,2	0,2	80
	200	15	12	12	9	8	7	6	5	5	4	4	3	3	3	3		0,2	0,1	0,1	0,1	96
	240	13	10	10	7	6	6	5	4	4	4	3	3	3	2	2	2		0,1	0,1	0,1	120
	300	12	9	9	7	6	5	4	4	4	3	3	3	2	2	2	2	1		0,1	0,1	128
320	13	10	9	7	6	6	5	4	4	3	3	3	2	2	2	2	1	1		0,1	144	
360	11	9	8	6	6	5	4	4	3	3	3	2	2	2	2	1	1	1	1			
		20	25	30	40	45	50	60	75	80	90	100	120	150	180	200	240	300	320	360		

SQUARE FORMATS		
cm / inch	x m2 / x10 sq.ft.	x m2 / x10 sq.ft.
10 X 10 4" X 4"	140	230
15 X 15 6" X 6"	63	103
20 X 20 8" X 8"	35	58
30 X 30 12" X 12"	16	26
33 X 33 13" X 13"	13	22
40 X 40 16" X 16"	9	15
45 X 45 18" X 18"	7	12
50 X 50 20" X 20"	6	10
60 X 60 24" X 24"	4	7
75 X 75 30" X 30"	3	5
80 X 80 31" X 31"	3	4
90 X 90 35" X 35"	2	3

RECTANGULAR FORMATS		
cm / inch	x m2 / x10 sq.ft.	x m2 / x10 sq.ft.
15 X 60 6" X 24"	16	26
15 X 90 6" X 35"	10	18
15 X 120 6" X 47"	8	13
20 X 40 8" X 16"	18	29
20 X 60 8" X 24"	12	20
20 X 80 8" X 31"	9	15
20 X 100 8" X 40"	7	12
25 X 100 10" X 40"	6	10
30 X 60 12" X 24"	8	13
30 X 90 12" X 35"	6	9
30 X 120 12" X 48"	4	7
40 X 80 16" X 31"	5	8

LARGE SPECIAL FORMATS		
cm / inch	x pz.	x pz.
100 X 150 40" X 59"	2	4
100 X 300 40" X 118"	2	4
120 X 120 48" X 48"	2	4
120 X 360 48" X 142"	2	4
150 X 150 59" X 59"	2	4
150 X 300 59" X 118"	2	4



# DELTA LEVEL SYSTEM: LEVELLING SYSTEM



## • SYSTEM TO FACILITATE THE LAYING AVOID LIPPAGE AND IMPROVING FINISHING.

- Avoids lippage during tile laying in both floor and walls.
- For tile formats from 30x30 cm (12"x12") or bigger. Always with back buttering.
- EASY and INTUITIVE use.
- Impact removal system. ALWAYS in the direction of the grout.
- Guarantee flatness and regularity of the laying surface.
- Reusable wedges.
- STURDY pliers with pressure adjustment according to the tile thickness.

◇ CATEGORY: SUPERPRO



### KIT DELTA LEVEL SYSTEM

- The kit consists of 1 pliers, 100 strips and 100 reusable wedges.
- Packaged in a handy bucket.

	REF.		
KIT DELTA LEVEL SYSTEM 1MM (3-12MM)	03956	1	80
KIT DELTA LEVEL SYSTEM 1,5MM (3-12MM)	03957		
KIT DELTA LEVEL SYSTEM 2MM (3-12MM)	03958		

◇ CATEGORY: SUPERPRO



PATENTED

### DELTA LEVEL SYSTEM WEDGE N

- Prevents the generation of lippage during ceramic tile installation, both in flooring and on walls.
- Recommended for formats of 30x30 cm and above, always with back buttering.

	REF.		
DELTA LEVEL SYSTEM WEDGE N (8-100 UN)	03952	12	192
DELTA LEVEL SYSTEM WEDGE N (8-200 UN)	03953	13	104
DELTA LEVEL SYSTEM WEDGE N (8-400 UN)	03954	6	48
DELTA LEVEL SYSTEM WEDGE N (C-1200 UN)	03955	1	16

◇ CATEGORY: SUPERPRO



PATENTED

### DELTA LEVEL SYSTEM PLIERS FAST-FIX

- FAST-FIX regulation system. Without screws, faster and intuitive.
- Made of steel with bi-material soft-grip handles for greater ergonomics.
- Protective cover on the pressure cam to avoid damaging the tile.

	REF.	
DELTA LEVEL SYSTEM PLIERS FAST-FIX	03901	6

◇ CATEGORY: SUPERPRO



### LEVELLING CERAMIC PROTECTOR

- To protect the tiles against scratching or abrasive damage caused by friction between wedges, caps and delicate tiles, particularly in the presence of sand or hard particles.
- For Delta System wedges or Cyclone system threads.
- Reusable.

	REF.			
LEVELLING CERAMIC PROTECTOR	16902	100	10.80254 lb 4,9 kg	6

**CATEGORY: SUPERPRO**

**DELTA LEVEL SYSTEM STRIP**

- Made in PP.
- Different models available:
- Strip 0,5 mm / 1 mm / 1,5 mm and 2 mm. for tiles from 3 to 12 mm.
- Strip 1,5 mm and 2 mm for tiles from 11 to 20 mm.
- 3 mm and 5 mm strip for tiles from 6 to 15 mm.
- 5 mm strip for tiles from 13 to 20 mm.



	REF.		
STRIP 3-12MM 0,5MM DELTA LEVEL SYSTEM (B-100 UN)	03929	22	352
STRIP 3-12MM 0,5MM DELTA LEVEL SYSTEM (B-200 UN)	03930	21	168
STRIP 3-12MM 0,5MM DELTA LEVEL SYSTEM (B-400 UN)	03931	13	104
STRIP 3-12MM 0,5MM DELTA LEVEL SYSTEM (B-2400 UN)	03932	1	16
STRIP 3-12MM 1MM DELTA LEVEL SYSTEM (B-100 UN)	02850	22	352
STRIP 3-12MM 1MM DELTA LEVEL SYSTEM (B-200 UN)	02851	21	168
STRIP 3-12MM 1MM DELTA LEVEL SYSTEM (B-400 UN)	02839	13	104
STRIP 3-12MM 1MM DELTA LEVEL SYSTEM (B-2400 UN)	02870	1	16
STRIP 3-12MM 1,5MM DELTA LEVEL SYSTEM (B-100 UN)	02840	22	352
STRIP 3-12MM 1,5MM DELTA LEVEL SYSTEM (B-200 UN)	02841	21	168
STRIP 3-12MM 1,5MM DELTA LEVEL SYSTEM (B-400 UN)	02842	13	104
STRIP 3-12MM 1,5MM DELTA LEVEL SYSTEM (B-2400 UN)	02855	1	16
STRIP 3-12MM 2MM DELTA LEVEL SYSTEM (B-100 UN)	02852	22	352
STRIP 3-12MM 2MM DELTA LEVEL SYSTEM (B-200 UN)	02853	24	192
STRIP 3-12MM 2MM DELTA LEVEL SYSTEM (B-400 UN)	02854	13	104
STRIP 3-12MM 2MM DELTA LEVEL SYSTEM (B-2400 UN)	02856	1	16
STRIP 6-15MM 3MM DELTA LEVEL SYSTEM (B-100 UN)	02866	20	320
STRIP 6-15MM 3MM DELTA LEVEL SYSTEM (B-200 UN)	02867	21	168
STRIP 6-15MM 3MM DELTA LEVEL SYSTEM (B-400 UN)	02868	11	88
STRIP 6-15MM 3MM DELTA LEVEL SYSTEM (B-2400 UN)	02869	1	16
STRIP 6-15MM 5MM DELTA LEVEL SYSTEM (B-200 UN)	06827	21	168
400 CLIPS 3/16" DELTA LEV. SYS (1/4"-9/16")	06828	11	88
2400 CLIPS 3/16" DELTA LEV. SYS (1/4"-9/16")	06829	1	16
STRIP 11-20MM 2MM DELTA LEVEL SYSTEM (B-100 UN)	02858	20	320
STRIP 11-20MM 1,5MM DELTA LEVEL SYSTEM (B-100 UN)	02846		
STRIP 13-20MM 5MM DELTA LEVEL SYSTEM (B-100 UN)	06981		240





# CYCLONE LEVEL SYSTEM: LEVELLING SYSTEM



## • SYSTEM TO FACILITATE THE LAYING AVOID LIPPAGE AND IMPROVING FINISHING.

- A tool is not required for their installation.
- EASY, QUICK and INTUITIVE to USE. Results less dependent on the skill and experience of the user.
- LARGE and ERGONOMIC Cap. Does not injure fingers when tightening.
- GUARANTEES the flatness and uniformity of the installation surface.
- System removal by IMPACT (kick or mallet). ALWAYS in the direction of the grout joint.
- Reusable caps.
- The base of the clip ensures continuous tension between the clip and the cap.
- The lateral grooves at the base of the clip FACILITATE the spread of the adhesive, thus improving the adhesion of the tile.
- Tightening adjustment system depending on the thickness of the ceramic tile.
- Recommended for tiles with thicknesses from 3 to 20 mm.

◆ CATEGORY: SUPERPRO



### CYCLONE KIT

- The kit consists of 300 clips and 100 reusable caps.
- Packaged in a practical bucket.

	REF.	
KIT CYCLONE 1,5 MM	35964	3
KIT CYCLONE 3 MM	35965	
KIT CYCLONE 5 MM	35903	1

◆ CATEGORY: SUPERPRO



PATENT PENDING

### CYCLONE CAPS

- Reusable.
- Special 6 mm external thread.
- Eccentric detail for better force concentration.
- Crowned area for better grip.
- Dimensions: 59x59x38 mm
- Supplied in reusable container.

	REF.		
CYCLONE CAPS [B-100]	35949	1	80
CYCLONE CAPS [B-300]	35950		32
CYCLONE CAPS [B-1200]	35951		16

◆ CATEGORY: SUPERPRO



### LEVELLING CERAMIC PROTECTOR

- To protect the tiles against scratching or abrasive damage caused by friction between wedges, caps and delicate tiles, particularly in the presence of sand or hard particles.
- For Delta System wedges or Cyclone system threads.
- Reusable.

	REF.			
LEVELLING CERAMIC PROTECTOR	16902	100	10.80254 lb 4,9 kg	6

**CATEGORY:  
SUPERPRO**



### CYCLONE FLAT BASE

- Available in various models:
- Flat base clips of 1, 1.5, 2, 3 and 5 mm.
- Visual thickness identification by colour.

	REF.		
CYCLONE L.S. 1 MM FLAT BASE (B-100)	35937	36	432
CYCLONE L.S. 1 MM FLAT BASE (B-300)	35938	12	144
CYCLONE L.S. 1 MM FLAT BASE (B-2400)	35939	1	20
CYCLONE L.S. 1.5 MM FLAT BASE (B-100)	35940	36	432
CYCLONE L.S. 1.5 MM FLAT BASE (B-300)	35941	12	144
CYCLONE L.S. 1.5 MM FLAT BASE (B-2400)	35942	1	16
CYCLONE L.S. 2 MM FLAT BASE (B-100)	35943	36	432
CYCLONE L.S. 2 MM FLAT BASE (B-300)	35944	12	144
CYCLONE L.S. 2 MM FLAT BASE (C-2400)	35945	1	16
CYCLONE L.S. 3 MM FLAT BASE (B-100)	35946	36	432
CYCLONE L.S. 3 MM FLAT BASE (B-300)	35947	12	144
CYCLONE L.S. 3 MM FLAT BASE (C-2400)	35948	1	16
CYCLONE L.S. 5 MM FLAT BASE (B-100)	35900	36	432
CYCLONE L.S. 5 MM FLAT BASE (B-300)	35901	12	144
CYCLONE L.S. 5 MM FLAT BASE (C-2400)	35902	1	16

**CATEGORY:  
SUPERPRO**



### CYCLONE CROSS BASE

- Available in various models:
- Cross base clips of 1.5 and 3 mm.
- Visual thickness identification by colour.

	REF.	
CYCLONE L.S. 1.5 MM CROSS BASE (B-100)	35952	36
CYCLONE L.S. 1.5 MM CROSS BASE (B-300)	35953	12
CYCLONE L.S. 3 MM CROSS BASE (B-300)	35956	

**CATEGORY:  
SUPERPRO**



### CYCLONE CROSS T BASE

- Available in various models:
- 1.5 and 3 mm T-base flanges.
- Visual identification of thickness by colours.

	REF.	
BASE T 1,5 MM CYCLONE LS (B-100)	35958	36
CYCLONE L.S. 1.5 MM CROSS T BASE (B-300)	35959	12
BASE T 3 MM CYCLONE LS (B-100)	35961	36
CYCLONE L.S. 3 MM CROSS T BASE (B-300)	35962	12



# RUBBLE CHUTES BUCKETS & TUBS

---

Rubble chutes  
Plastic products for construction





# REINFORCED PLASTIC RUBBLE CHUTES "LIGHTCHUTE"



- **PLASTIC RUBBLE CHUTES ARE A SAFE AND ECONOMICAL WAY TO MOVE RUBBLE AND OTHER SITE WASTE FROM HIGH STOREYS TO CONTAINERS AT STREET LEVEL. THEIR EASE OF USE MEANS THAT THEY CAN BE UTILIZED TO GREAT EFFECT IN ANY BUILDING WORK OVER SEVERAL STOREYS. RUBBLE CHUTES ARE ESPECIALLY RECOMMENDABLE IN URBAN SURROUNDINGS.**
- **RIBBED INTERIOR PROTECTS AGAINST WEAR AND TEAR. GREATER DURABILITY.**
- **DUST REDUCTION.**
- **FAST AND EASY ASSEMBLY. EQUIPPED WITH QUICK-CLIP SYSTEM.**
- **STACKABLE; SAVING SPACE IN STORAGE AND TRANSIT.**
- **WIDE RANGE OF ACCESSORIES.**

**CATEGORY: SUPERPRO**

## TOP PLASTIC RUBBLE CHUTE "LIGHTCHUTE"



- For loading waste on lightchute chutes.
- Also compatible as top Hopper or an intermediate loading point.
- Excellent resistance to impact by deformation.
- Higher durability.
- 6 mm thick walls with ribbed interior that protects against wear and tear.
- Reduces dust.
- Equipped with 6 mm thick chains, according to DIN 763 norm.
- Locking chain of 3 mm for intermediate chutes.
- Fast and easy assembly. Equipped with quick-clip system.
- Stackable for saving space.



REF.								
<b>TOP PLASTIC RUBBLE CHUTE "LIGHTCHUTE"</b>	88765	19 1/8" 485 mm	17 3/4" 450 mm	21 1/4" 54 cm	19 5/8" 50 cm	1/4" 6 mm	12.57 lb 5.7 kg	1

**CATEGORY: SUPERPRO**

## PLASTIC RUBBLE CHUTE STANDARD SECTION "LIGHTCHUTE"



- Attaches to sections with top and side hoppers and all other chute accessories.



REF.									
<b>PLASTIC RUBBLE CHUTE STANDARD SECTION</b>	88760	18 1/2" 470 mm	14" 380 mm	42 1/8" 107 cm	39 3/8" 100 cm	1/4" 6 mm	18.518 lb 8.4 kg	1	24



## ACCESSORIES FOR RUBBLE CHUTES

- WIDE RANGE OF ACCESSORIES FOR RUBBER AND PLASTIC RUBBLE CHUTES.
- THEY PROVIDE A FASTER, SAFER AND MORE COMFORTABLE WAY OF FIXING THE CHUTE TO A BUILDING OR SCAFFOLDING.

**1**  
Prepare

CATEGORY:  
PREMIUM



### CHUTE SCAFFOLD FASTENING SYSTEM

- Mounting bracket to fix top of chute to scaffold.
- Reinforced. Holds the weight of the chutes that hang from it.
- Easily fixes to the scaffold.
- For greater safety and security we recommend installing this piece at intermediate sections of the chute column. Specifically, one piece every 15 metres of chute.

	REF.	
CHUTE SCAFFOLD FASTENING SYSTEM	88517	1



## PLASTIC BUCKETS "LIGHTBUCK"

- HIGH QUALITY PLASTIC BUCKETS ARE AN OUTSTANDING OPTION DUE TO THEIR COMPETITIVE PRICE AND LIGHT WEIGHT. THE RANGE OF PLASTIC BUCKETS INCLUDES MODELS WITH CAPACITIES OF 10, 12, 15 AND 22 LITRES.
- THE COMMON CHARACTERISTICS OF ALL THE PLASTIC BUCKETS ARE:
- MADE WITH HIGH QUALITY POLYETHYLENE. GREATER ROBUSTNESS.
- SUITABLE FOR ALL TYPES OF WORK IN THE CONSTRUCTION INDUSTRY AS WELL AS OTHER INDUSTRIES.
- VERY THICK WALLS FOR MAXIMUM STRENGTH AND RESISTANCE.



**CATEGORY:**  
PRO



### ITALIANO PLASTIC BUCKET "LIGHTBUCK" (10 L.)

- Greater comfort during transport. For easy waste collection.
- Highly resistant metal handle.
- Walls are reinforced with ribbing.

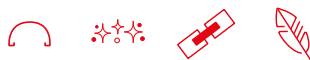

	REF.						
"ITALIANO" PLASTIC BUCKET (10 L.)	88770	-" - cm	-" - mm	10 l.	2,2046 lb 1 kg	10	600

**CATEGORY:**  
PRO



### PLASTIC BUCKET WITH GRADUATION "LIGHTBUCK" (12 L.)

- Greater comfort during transport. For easy waste collection.
- Embossed scale.
- Highly resistant metal handle.
- Walls are reinforced with ribbing.



	REF.					
PLASTIC BUCKET WITH GRADUATION (12 L.)	88776	-" - cm	-" - mm	12 l.	2,2046 lb 1 kg	1

**CATEGORY:**  
PRO



### PLASTIC BUCKET WITH GRADUATION & SPOUT "LIGHTBUCK" (15 L.)

- Greater comfort during transport. For easy waste collection.
- Embossed scale.
- With spout to prevent spillages when pouring.
- With reinforced rim for greater resistance.
- Highly resistant metal handle.
- Walls are reinforced with ribbing.



	REF.					
PLASTIC BUCKET WITH GRADUATION & SPOUT (15 L.)	88775	-" - cm	-" - mm	15 l.	2,64552 lb 12 kg	1



**CATEGORY:**  
PRO



**PLASTIC BUCKET MODEL 2 "LIGHTBUCK" HANDLE EXT. (20 L.)**

- Greater comfort during transport. Easy waste collection.
- Heavy duty metal handle.
- Plastic handle. Comfort.



	REF.					
<b>PLASTIC BUCKET MODEL 2 "LIGHTBUCK" HANDLE EXT. (20 L.)</b>	88712	14 5/8" 370 mm	10 5/8" 27 cm	20 l.	1.87391 lb 0,85 kg	1

**CATEGORY:**  
PRO



**PLASTIC BUCKET MODEL 2 "LIGHTBUCK" (20 L.)**

- Greater comfort during transport. Easy waste collection.
- Heavy duty metal handle.
- Plastic handle. Comfort.



	REF.						
<b>PLASTIC BUCKET MODEL 2 WITH PLASTIC HANDLE (20 L.)</b>	88772	14 5/8" 370 mm	10 5/8" 27 cm	22 l.	2.201b 1 kg	1	450





# PLASTIC TUBS "FLEXTUB"

- THE HIGH QUALITY PLASTIC TUBS ARE SUITABLE FOR USE IN VARIOUS INDUSTRIES, COMBINE OPTIMAL RESISTANCE WITH GOOD FLEXIBILITY AND ARE VERY LIGHTWEIGHT. THEIR SHAPE AND THE DESIGN OF THEIR HANDLES MEANS THAT ANY OF THE PLASTIC TUBS IN THIS RANGE CAN BE CARRIED IN ONE HAND WITH NO RISK OF BREAKAGE OR FATIGUE.
- THE COMMON CHARACTERISTICS OF ALL THE PLASTIC BASKETS ARE:
- MADE WITH HIGH QUALITY POLYETHYLENE. GREATER ROBUSTNESS.
- SUITABLE FOR ALL TYPES OF WORK IN THE CONSTRUCTION INDUSTRY AS WELL AS OTHER INDUSTRIES.
- VERY THICK WALLS FOR MAXIMUM STRENGTH AND RESISTANCE.



▲ CATEGORY: PRO



## PLASTIC BUCKETS "HEAVY DUTY"

- Greater comfort during transport. For easy waste collection.
- Reinforced handles. Greater resistance.
- Lightweight.



	REF.						
<b>BLACK PLASTIC BUCKET NO.3 (40 L.) HEAVY DUTY</b>	88778	12" 33 cm	17 3/8" 440 mm	40 l.	2,425 lb 1.1 kg	10	300

▲ CATEGORY: PRO



## PLASTIC TUBS №. 1 "FLEXTUB" (25 L.)

- Greater comfort during transport. For easy waste collection.



	REF.						
<b>PLASTIC TUB BLACK COLOUR №. 1 (25 L.)</b>	88771	11 3/4" 30 cm	14 1/8" 360 mm	25 l.	1,76368 lb 0.8 kg	10	450

▲ CATEGORY: PRO



## PLASTIC TUB №. 4 "FLEXTUB" (55 L.)

- Greater comfort during transport. For easy waste collection.
- Lightweight.



	REF.						
<b>PLASTIC TUB BLACK COLOUR №. 4 (55 L.)</b>	88774	12" 33 cm	20 7/8" 530 mm	55 l.	3,52736 lb 1.6 kg	10	200



**CATEGORY: PRO**



**PLASTIC TUB Nº. 3 "FLEXTUB" (40 L.)**

- Greater comfort during transport. For easy waste collection.
- Reinforced handles. Greater resistance.
- Lightweight.
- Made with recycled material.



	REF.						
PLASTIC TUB BLACK COLOUR Nº. 3 (40 L.)	88773						300
PLASTIC TUB RED COLOUR Nº. 3 (40 L.)	88726						
PLASTIC TUB YELLOW COLOUR Nº. 3 (40 L.)	88720						
PLASTIC TUB BLUE COLOUR Nº. 3 (40 L.)	88721	12" 33 cm	17 3/8" 440 mm	40 l.	2.86598 lb 1.3 kg	10	
PLASTIC TUB GREEN COLOUR Nº. 3 (40 L.)	88728						
PLASTIC TUB PISTACHIO COLOUR Nº. 3 (40 L.)	88725						
PLASTIC TUB ORANGE COLOUR Nº. 3 (40 L.)	88724						





# **SAFETY EQUIPMENT**



Personal equipment for construction professionals



# KNEE PADS, ERGONOMIC SEAT AND CUSHION

## • RANGE OF KNEE PADS AND ERGONOMIC SEAT.

**3**  
Set

**CATEGORY:**  
PRO

**ALL TERRAIN 4X4**

### KNEE CUSHION

- Polyurethane cushion for protecting the knees.
- Makes it easy to work on the floor without using knee pads.
- Its wide surface allows its use as a seat.

**REF.**

KNEE CUSHION	65943	1
--------------	-------	---

**CATEGORY:**  
PRO

**ALL TERRAIN 4X4**

### FLEX KNEE PADS

- Protection ergonomic flexible. Adjustable elastic band fastener.
- Professional knee pads of high comfort.
- Inner body soft materials suitable to the user.
- Flexible and resistant outer shell.
- Conforms to EN14404.
- Protection level: 1.

**REF.**

FLEX KNEE PADS	81994	6
----------------	-------	---

**CATEGORY:**  
SUPERPRO

**ALL TERRAIN 4X4**

### PROFESSIONAL KNEE PADS N

- Useful for any task that requires kneeling for prolonged periods of time.
- Ideal for much more comfortable installation of tiles and flooring in general in different phases of the installation: substrate preparation, installation, grouting and cleaning.
- LARGE SUPPORT surface area for optimal STABILITY and COMFORT.
- Double strap for keeping the knee pad tightly fitted to the leg at all times.
- Avoids blocking of blood flow at the back of the knee.
- Quick strap fastening.
- In accordance with EN14404.
- Performance level: 1.

**REF.**

SET OF PROFESSIONAL KNEE PADS N	66957	6	192
---------------------------------	-------	---	-----



**CATEGORY:**  
SUPERPRO

**HARD SURFACES**

### GEL COMFORT KNEE PADS



- Ergonomic design professional and high comfort knee pads.
- Its design combines the use of hard materials against impacts and uneven floors and soft materials therein, adapted to the user's anatomy.
- In addition to protecting the user's knees through the use of silicone gel inside, its studied ergonomics provide them with great stability, preventing ligaments and tendons fatigue.
- They incorporate two bands Neoprene closure.
- Conforms to EN14404.
- Protection level: 1.

**REF.**



**GEL COMFORT KNEE PADS**

81998

6

96

**CATEGORY:**  
PREMIUM

**HARD SURFACES**

### GEL DUPLEX KNEE PADS



- Professional knee pads with ergonomic design. Highly comfortable.
- Their design combines the use of hard materials to protect against impacts and uneven floors and soft materials adaptable to the user's anatomy on the inside.
- Besides protecting the user's knees thanks to the silicone gel in their inside, their studied ergonomics gives them great stability, preventing ligaments and tendons fatigue.
- Wide range of uses thanks to their design "two in one":
- Can be used together with the external rubber protection of great stability and resistance.
- With the main body only, less bulky, which allows the knee to slide without problem over smooth surfaces.
- They incorporate a double fastener, inferior and superior, easy adjustable.
- Conforms to EN14404.
- Protection level: 1.

**REF.**



**GEL DUPLEX KNEE PADS**

81989

6

144





**CATEGORY: SUPERPRO**

**HIGH LOAD CAPACITY**

**HARD SURFACES**

**SR-1 ERGONOMIC SEAT**



- Aluminium chassis high strength and stability.
- Allows an ergonomic position of comfort.
- Prevents injuries in knees and back.
- Adjustable seat height and angle for optimum adaptation to each use.
- Robust construction with 7 heavy duty wheels.
- Includes tray for tools and accessories.
- Ideal for flooring, parquet installation, cleaning and other operations on pavements tasks.
- Replaceable ergonomic kneepads.
- Maximum weight: 286 lb (130 kg).

	REF.		
<b>SR-1 ERGONOMIC SEAT</b>	81999	1	18



# SAFETY EQUIPMENT

## PERSONAL PROTECTIVE EQUIPMENT FOR BUILDING PROFESSIONALS



CATEGORY: SUPERPRO



### WHITE LENS GOGGLES

- Field of use: basic.
- Mechanical resistance to high speed particles, low energy.
- Extendable in length and vertically adjustable side pieces.
- Anti-scratch and anti-fog.
- UV Filter.
- Comfortable and light.
- Conforms to EN166 and EN170

	REF.	
WHITE LENS GOGGLES	80918	12

CATEGORY: SUPERPRO



### EAR PROTECTOR

- Comfortable and effective protection for high noise environments.
- Conforms to EN352-1.

	REF.	
EAR PROTECTOR	80903	6

CATEGORY: SUPERPRO



### LUMBAR PROTECTOR

- Recommended to avoid low-back injuries when loading weight or maintain fixed positions.
- With vertical reinforcement in the lower-back area.
- Side devices to adjust the pressure at the time of stress.
- Available in 3 sizes: M, L and XL

	REF.	
LUMBAR PROTECTOR - L [37 13/16"-40 15/16"] [96-104 CM]	80913	1
LUMBAR PROTECTOR - XL [40 15/16"-44 1/8"] [104-112 CM]	80914	

CATEGORY: SUPERPRO



### LATEX GLOVES

- Ideal for wet or abrasives tasks.
- For minimal risks only.
- Made of 100% latex.
- Conforms to EN420.

	REF.		
LATEX GLOVES	20907	12	3240

CATEGORY: SUPERPRO



### SET OF SMOOTH SOLES

- Increases contact by 100% approx.

	REF.	
SET OF SMOOTH SOLES	05985	1



**ACCESSORIES FOR  
CLEANUP AND  
MAINTENANCE**

---

Products and accessories for cleaning and installing ceramic tile





## PRODUCTS FOR CLEANING

- 25 L. AND 200 L. PACKAGES AVAILABLE ON REQUEST, MINIMUM ORDER APPLIES (400 L.)



CATEGORY:  
SUPERPRO

### RC-10 CEMENT REMOVER

- Product specially made for cleaning cement, mortar, tile cement and any limestone base substance. Also suitable for spot cleaning of efflorescence (salt) on brick walls, terraces or baked tiles etc...



	REF.	
RC-10 CEMENT REMOVER 5 L. (ONLY AVAILABLE FOR SPAIN, FRANCE, UK, ITALY & CUBA)	22950	2

## SPONGES, FLOATS AND PADS

- COMPLETE RANGE OF SPONGES AND GROUT FLOATS FOR CLEANING AND PROTECTION OF TILES.



CATEGORY:  
SUPERPRO

### SUPERPRO SPONGES

- PLUS models have cuts for increased drag on the dirt.
- Ref. 20905 and 20906 available in Palbox.



	REF.					
SUPERPRO SPONGE	20905	7 7/8x5 1/8x2 3/4" 20x13x7 cm	1	2	24	384
SUPERPRO SPONGE PLUS	20917					288
SWEEPEX SUPERPRO SPONGE	20928	7 1/8x3 7/8x2 3/4" 18x10x7 cm	3	3	24	384
SWEEPEX SUPERPRO SPONGE PLUS	20932					
MIXED SUPERPRO SPONGE	20906	7 7/8x5 1/8x2 3/4" 20x13x7 cm	4	2	24	288
MIXED SUPERPRO SPONGE PLUS	20918					
MIXED SWEEPEX SUPERPRO SPONGE SPECIAL FOR JOINTS	20992	7 1/8x3 7/8x2 3/4" 18x10x7 cm	4	3	24	792
EPOXY CELLULOSE SUPERPRO SPONGE	22928					6 3/4x3 7/8x1 5/8" 17x10x4 cm
MIXED EPOXY CELLULOSE SUPERPRO SPONGE	22929	6 3/4x3 7/8x1 5/8" 17x10x5 cm	4	4	24	640
						10



**CATEGORY: PRO**



**PRO SPONGES**

- Polyurethane sponges.
- HIDRO models are highly absorbent.

	REF.					
<b>STANDARD PRO SPONGE</b>	24966	6 3/4x3 7/8x2 3/4"	2	1	24	720
<b>HIGH ABSORPTION HIDRO PRO SPONGE</b>	24967	17x10x7 cm	3	3		-

**CATEGORY: SUPERPRO**



**SPONGE FLOAT SUPERPRO**

- Floats with SUPERPRO sponge for grout cleaning and finishing.
- PLUS model has cuts for increased performance in wiping away dirt.

	REF.					
<b>SPONGE FLOAT SUPERPRO</b>	20924	11 1/8x7 5/8x" 28x19.5x2.5 cm	1	2	10	180
<b>SPONGE FLOAT SUPERPRO PLUS</b>	20908					120

**CATEGORY: PRO**



**SPONGE FLOAT PRO**

- Polyurethane foam floats with high absorption.
- The PLUS model has slits for increased performance drag dirt.

	REF.					
<b>SPONGE FLOAT PRO</b>	24974	11 1/8x5 1/2x1 1/8"	3	3	10	-
<b>SPONGE FLOAT PRO PLUS</b>	24988	28x14x3 cm				240

**CATEGORY: SUPERPRO**



**REPLACEABLE SUPERPRO SPONGES 12" X 5 11/32" (30X13,5CM)**

- Float sponges for cleaning and finishing tile and grout jobs. Interchangeable sponges adaptable to the ergonomic handle. (Ref. 22912) and secure attachment to other brands.
- Sponges available with different levels of absorption and resistance to abrasion. Comfortable and secure attachment system.
- PLUS models have cuts for increased drag on the dirt.

	REF.					
<b>FLOAT WITH REPLACEABLE SUPERPRO SPONGE</b>	22900	11 3/4x5 3/8x1 5/8" 30x13.5x4 cm	1	2	10	180
<b>FLOAT WITH REPLACEABLE SWEEPEX SUPERPRO SPONGE</b>	22916		3	3		320
<b>REPLACEABLE SUPERPRO SPONGE</b>	22910		1	2		-
<b>REPLACEABLE SUPERPRO SPONGE PLUS</b>	22918					
<b>REPLACEABLE EPOXY CELLULOSE SUPERPRO SPONGE</b>	22932	11 3/4x5 3/8x1 1/8" 30x13.5x3 cm	4	4	10	240
<b>REPLACEABLE SWEEPEX SUPERPRO SPONGE</b>	22922		3	3		320
<b>REPLACEABLE SWEEPEX SUPERPRO SPONGE PLUS</b>	22914	11 3/4x5 3/8x1 5/8" 30x13.5x4 cm				



CATEGORY:  
SUPERPRO



### HANDLE FOR INTERCHANGEABLE SPONGES AND FOAMS

- Adaptable to 12" x 5 11/32" (30 x 13.5 cm.)
- and 13 13/32" x 6 3/4" (34 x 17 cm.) SUPERPRO sponges and foam replacements.

	REF.	
INTERCHANGEABLE HANDLE FOR SPONGES AND FOAMS	22912	10

CATEGORY:  
SUPERPRO



### RUBBER FOAM SUPERPRO FLOAT REPLACEMENTS

- Rubber foam sponges basis for finishing and final cleanings, adaptable to ergonomic handle (Ref. 22912)
- Available with different hardness and abrasiveness rubber-foam.

	REF.		
REPLACEMENT RUBBER FOAM BIG CELL SOFT-L SUPERPRO	22924	11 3/4x5 3/8x3/8" 30x13.5x1 cm	10

CATEGORY:  
SUPERPRO



### RUBBER FOAM PLASTIC HANDLE SUPERPRO FLOATS

- For surface finishing and final cleaning.
- Ergonomic plastic handle.
- Different types of rubber foam and hardness, depending on the type of finish.

	REF.			
RUBBER FOAM BIG CELL SOFT-L SUPERPRO FLOAT	72985	9 7/8x4 3/8x5/8" 25x11x1.5 cm	6	540
RUBBER FOAM MEDIUM CELL SOFT-M SUPERPRO FLOAT	72986			
RUBBER FOAM SMALL CELL HARD-S SUPERPRO FLOAT	72988			

CATEGORY:  
PRO



### RUBBER FOAM PRO FLOAT

- For finishing and final cleaning of surfaces.

	REF.			
COARSE RUBBER FOAM PRO FLOAT 11 1/32" X 5 1/2" [28 X 14 CM.]	24971	11 1/8x5 1/2x3/4" 28x14x2 cm	10	360
FINE RUBBER FOAM PRO FLOAT 11 1/32" X 5 1/2" [28 X 14 CM.]	24973	11 1/8x4 3/4x3/4" 28x12x2 cm		

CATEGORY:  
SUPERPRO



### SUPERPRO SPONGE WITH BASE

- Large area reinforced base.
- Handle included (Ref.70904).
- Polyurethane Sponge.
- Not compatible with RUBICLEAN EASY SQUEEZE bucket.

	REF.					
SWEEPEX SUPERPRO SPONGE WITH BASE	20914	13 3/8x6 3/4x1"	3	3	1	168
REPLACEMENT SWEEPEX SUPERPRO SPONGE WITH BASE FOR WASHBOY	20919	34x17x5 cm				





CATEGORY: PREMIUM

NEW!



### BASE SPONGE EASY SQUEEZE

• Hydro floor trowel, 42x13x3 cm, easy to replace with velcro. Includes detachable aluminium handle.

	REF.	
BASE SPONGE WITH STICK EASY SQUEEZE	68992	1
BASE SPONGE REPLACEMENT EASY SQUEEZE	68993	

CATEGORY: SUPERPRO



### FLOAT WITH 10" (25 CM.) SUPERPRO PADS

- To clean ceramic surfaces and other materials.
- Float with three different roughness replaceable pads; soft (red), medium (blue) and hard (brown).
- Float with three very stuff pads (white).
- 3 sets of pads: very soft (white), soft (red), medium (blue) and hard (brown).
- Available set of 3 pads of different roughness: soft (red), medium (blue) and hard (brown).

	REF.		
FLOAT + 3 MIXED PADS	20900	9 7/8x3 7/8x" 25x10x2.5 cm	1
FLOAT + 3 VERY SOFT PADS	20944		
3 PADS REPLACEMENT SET - VERY SOFT	20971		
3 PADS REPLACEMENT SET - MEDIUM	20973		
3 PADS REPLACEMENT SET - HARD	20974		
3 PADS REPLACEMENT SET - SOFT/MEDIUM/HARD	20902		

STANDARD

SWEEPEX | HIDRO

CELLULOSA

ABRASIVE



Absorption level.

Resistance to abrasion.

SWEEPEX® is a registered trade mark.



# WASHBOYS

• **DIFFERENT MODEL OF WASHBOYS FOR CLEANING AWAY GROUT OR FINAL CLEAN OF TILING JOB.**



◇ CATEGORY: PREMIUM

**NEW!**



## RUBICLEAN EASY SQUEEZE

- Bucket for floors and walls. Foot-operated mechanism to facilitate the wringing of the sponge with handle. Two rollers for manual wall trowels. High-capacity tray, 32 litres. Two wheels and handle lock for improved transport.
- \*The pictures of this product might be slightly different to its final version.

	REF.			
<b>RUBICLEAN EASY SQUEEZE</b>	68991	1	8	24.2506 lb 11 kg

◇ CATEGORY: PRO



## RUBICLEAN PRO

- Plastic washboy with two squeeze rollers.
- Wheels built into the base.
- Capacity: 5.3 gl. (24 l.)
- Useful capacity: 3.7 gl. (17 l.)
- Dimensions: 20 1/2" x 10 5/8" x 10 1/4" (52 x 27 x 26 cm).
- Supplied assembled and in 1 unit case.
- Available in Palbox of 12 units (Ref. 69948).

	REF.		
<b>RUBICLEAN PRO WASHBOY</b>	25949	1	18

◇ CATEGORY: PRO



## RUBICLEAN PRO 1 SET

- Consisting of:
- RUBICLEAN PRO washboy (Ref. 25949).
- Sponge float PRO (Ref. 24974).
- Grout float PRO 11"x5"x13/32" (28x14x1cm) (Ref. 24969).

	REF.		
<b>RUBICLEAN PRO 1 SET</b>	68902	1	18

◇ CATEGORY: PRO



## RUBICLEAN PRO 2 SET

- Consisting of:
- RUBICLEAN PRO washboy (Ref. 25949).
- Float with replaceable SWEEPEX SUPERPRO sponge (Ref. 22916).
- Rubber grout float SUPERPRO (Ref. 65971).
- 45° Notched trowel 11" (28 cm) 13/32"x13/32" (10x10) (Ref. 75948).

	REF.		
<b>RUBICLEAN PRO 2 SET</b>	69949	1	18



CATEGORY:  
PRO



### RUBICLEAN EASYPRO

- Lightweight, strong plastic bucket.
- Lower grate level. Requires less water. More lightweight.
- Removable rollers. Easier cleaning.
- Metal reinforcement on the rollers. Greater resistance.
- Capacity 24 litres.

	REF.		
RUBICLEAN EASYPRO WASHBOY	21945	4	32

CATEGORY:  
SUPERPRO

4 WHEELS

3 ROLLERS



### RUBICLEAN TRIPLE SUPERPRO

- Plastic washboy, lightweight and high resistance.
- Equipped with 3 spiral rollers for further draining.
- Includes wheels and carrying handle.
- Capacity: 5.3 gl. (24 l.)
- Useful capacity: 2.2 gl. (10 l.)
- Dimensions: 20 7/8" x 11 1/32" x 14 9/16" (53 x 28 x 37 cm).
- Supplied assembled and in 1 unit box.

	REF.		
RUBICLEAN TRIPLE SUPERPRO WASHBOY	21995	1	18

CATEGORY:  
SUPERPRO



### RUBICLEAN SUPERPRO

- Plastic washboy, light and heavy duty, with two squeeze rollers and separation-decantation system of sewage.
- Includes wheels and carrying handle.
- Capacity: 5.3 gl. (24 l.)
- Useful capacity: 4.2 gl. (19 l.)
- Dimensions: 20 1/2" x 10 5/8" x 12" (52 x 27 x 30 cm).
- Supplied assembled and in 1 unit case.
- Available in Palbox of 10 units (Ref. 69964).

	REF.		
RUBICLEAN SUPERPRO WASHBOY	21998	1	18

CATEGORY:  
SUPERPRO



### RUBICLEAN SUPERPRO 2 SET

- Consisting of:
- RUBICLEAN SUPERPRO washboy (Ref. 21998).
- Sponge float SUPERPRO (Ref. 20924).
- Termoflex rubber grout float SUPERPRO (Ref. 65976).

	REF.		
RUBICLEAN SUPERPRO 2 SET	69915	1	18



# PAL BOX AND DISPLAYS

---

Index by references

**RUBI**

**BUILDING THE  
FUTURE TOGETHER**

**RUBI**

**BUILDING THE  
FUTURE TOGETHER**

**RUBI**





# PAL BOX AND DISPLAYS

• **PRODUCT DISPLAY UNITS FOR PLACEMENT OF PRODUCT AT SELLING POINT.**



◆ **CATEGORY: SUPERPRO**



## SUPERPRO SPONGE

- Contains x135 units of ref. 20905.
- Dimensions: 23" x 15" x 47" (60 x 40 x 120 cm).

	REF.		
SUPERPRO SPONGE PALBOX	69955	1	4

◆ **CATEGORY: SUPERPRO**



## MIXED SUPERPRO SPONGE

- Contains x135 units or ref. 20906.
- Dimensions: 23" x 15" x 47" (60 x 40 x 120 cm).

	REF.	
MIXED SUPERPRO SPONGE PALBOX	69957	1





**CATEGORY:**  
SUPERPRO



### RUBICLEAN SUPERPRO WASHBOY

- Contains x10 units of Ref. 21998.
- Washboys are NOT supplied assembled.
- Dimensions: 22" x 12" x 42" (56 x 31 x 109 cm).

	REF.	
RUBICLEAN SUPERPRO TRAY PALBOX	69964	1

**CATEGORY:**  
PRO



### RUBICLEAN PRO WASHBOY

- Contains x12 units of Ref. 25949.
- Washboys are NOT supplied assembled.
- Dimensions: 22" x 12" x 42" (56 x 31 x 109 cm).

	REF.	
RUBICLEAN PRO TRAY PALBOX	69948	1









# DISPLAYS

- **VARIOUS DISPLAY UNITS TO SHOW RUBI PRODUCTS, OPTIMISING SPACE AVAILABLE AND HELPING TO PROMOTE SALES.**



## GENERAL DISPLAY 1000 MM

- 1-metre wide general display stand.
- With a frame, stand and display tray. (Ref. 93911).
- With display bars. (Ref. 93910).
- If you want to set up multiple display stands, calculate the number of bars you will need.

	REF.	
<b>STRUCTURE + HEADER + GENERAL DISPLAY TRAY 1000MM +30 PRICE HOOKS</b>	93911	1
<b>2 UN. GENERAL DISPLAY BARS</b>	93910	



## GENERAL DISPLAY 650 MM

- 65-centimetre wide general display stand.
- With a frame, stand and display tray. (Ref. 93912).
- With display bars. (Ref. 93910).
- If you want to set up multiple display stands, calculate the number of bars you will need.

	REF.	
<b>STRUCTURE + HEADER + GENERAL DISPLAY TRAY 6500MM +25 PRICE HOOKS</b>	93912	1
<b>2 UN. GENERAL DISPLAY BARS</b>	93910	



**BUILDING THE  
FUTURE TOGETHER**





### GENERAL DISPLAY TRAY ACCESSORY

• Tray accessory for general display stand.

	REF.	
TRAY GENERAL DISPLAY 40" (1000 MM.)	90570	1
TRAY GENERAL DISPLAY 25" (650 MM.)	90571	



### GENERAL DISPLAY CAGE ACCESSORY

• Grid accessory for general display stand.

	REF.	
CAGE GENERAL DISPLAY 40" (1000 MM.)	90606	1
CAGE GENERAL DISPLAY 25" (650 MM.)	90607	



### ADJUSTABLE SEPARATOR ACCESSORY

• Spacer accessory for the general display stand

	REF.	
ADAPTABLE DIVIDER 400X200MM	93913	1



### MAGNETIC SUPPORT ACCESSORY FOR TROWELS AND NOTCHED TROWELS

• Support accessory with magnetic base for facilitating adjustment on the structure.  
• Support for Trowels and Notched Trowels.

	REF.	
MAGNETIC SUPPORT FOR TROWELS 650MM	93915	1
MAGNETIC SUPPORT FOR TROWELS 1000MM	93914	



### SUPPORT FOR TROWELS AND NOTCHED TROWELS ACCESSORY

• Support for Trowels and Notched Trowels Accessory for placement in general display.

	REF.	
HOOK BRICK TROWEL 400 MM	93916	1



**DISC SUPPORT ACCESSORY**

- Disc support accessory.
- It is necessary to use the disc support bar accessory for its correct assembly (Ref.93323/93318).

	REF.	
DISC SUPPORT	93917	1



**REINFORCEMENT BAR ACCESSORY FOR DISC SUPPORT**

- Disc support bar accessory.
- It is necessary to complement with the disc support accessory (Ref.93917).

	REF.	
REINFORCEMENT BAR 1000 MM	93918	1
REINFORCEMENT BAR ACCESSORY FOR DISC SUPPORT	93323	



**SUPPORT ACCESSORY FOR MALLETS AND HAMMERS**

- Support accessory for mallets and hammers, for their placing in the general display stand.

	REF.	
MALLETS & HAMMERS SUPPORT	93919	1



**SUPPORT ACCESSORY FOR SIDE SIGN**

- Support Accessory for hanging signs on general display stand.

	REF.	
SUPPORT ACCESSORY FOR SIDE SIGN 300MM	93920	1



**PRICE-HOLDER HOOK ACCESSORY**

- Price hook accessory for placement on general display stand.

	REF.	
PRICE-HOLDER HOOK ACCESSORY	93921	125







**SLAB CUTTER G3 DISPLAY STAND**

- Cardboard display to display the SLAB CUTTER G3 large format manual cutter (ref. 16900).
- Also to display the SLAB BREAKER PLUS accessories (ref. 18917) and the SLAB PLIER (ref. 28916).

	REF.	
SLAB CUTTER G3 DISPLAY STAND	41012	1



**MANUAL CUTTERS RACK (1 FACE)**

- Metal display stand with the capacity to display a manual cutter.
- It incorporates an anti-theft system.

	REF.	
MANUAL CUTTERS RACK (1 FACE)	93138	1

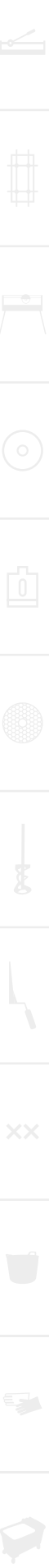



### DISPLAY FOR MANUAL TILE CUTTERS

- Capacity to display 3 manual tile cutters.



	REF.		
DISPLAY FOR MANUAL CUTTERS.	90305	1	6

### DISPLAY RANGE LEVELLING

- Cardboard dispenser display for the levelling range.



	REF.	
DISPLAY RANGE LEVELLING	93056	1

### DELTA LEVELLING DISPLAY STAND

- Dispenser display stand with 3 cardboard containers, for the Delta levelling range.



	REF.	
3 DISPENSERS DELTA LEVELLING DISPLAY	93906	1



**RUBI**

# DIAMOND EXPERT

—  
DRILL TO  
PERFECTION  
WITH TRIPLE  
THE LIFE

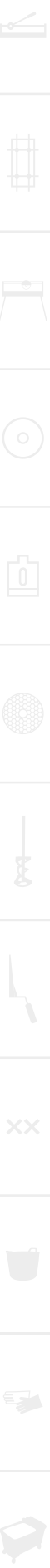



### RUBIMIX RANGE COLUMN DISPLAY STAND

- Display stand with several hooks to hold mixers and different paddles.

	REF.	
MIXERS RANGE COLUMN DISPLAY	93922	1



### PREMIUM DRILL BITS DESKTOP DISPLAY

- Table-top metal dispenser for drill bits. It incorporates an anti-theft system.

	REF.	
PREMIUM DRILL BITS DESKTOP DISPLAY	93800	1



### DISPLAY FOR 4DRILL BITS

- Desktop dispenser display with six hooks for hanging 4DRILL bits of different diameters.
- With front bar and key locking for anti-theft security.

	REF.	
DISPLAY FOR 4DRILL BITS	91907	1



### DISPLAY FOR RUBI DIAMOND BLADES

- Desktop Display for blade saws up to 5" (120mm).
- With front bar and key locking for anti-theft security.
- capacity: 36 blades 4 1/2", 5" (115mm,125mm).

	REF.	
DISPLAY FOR DIAMOND BLADES	92854	1

# INDEX BY REFERENCE

REF	PAG	REF	PAG	REF	PAG	REF	PAG	REF	PAG	REF	PAG	REF	PAG	REF	PAG	REF	PAG
01900	65	02856	249	04912	163	05966	168	10940	231	16909	95	20918	268	24994	194	27902	45
01901	82	02858	249	04913	163	05967	168	10971	97	16929	80	20919	270	24995	194	27903	45
01903	64	02861	245	04914	163	05969	168	10972	97	16946	138	20924	269	24996	194	27909	45
01906	66	02864	245	04915	163	05970	166	10973	97	16956	137	20928	268	24998	194	27911	81
01907	67	02866	249	04916	163	05971	166	11900	37	16957	138	20932	268	25900	212	27913	189
01945	66	02867	249	04917	163	05972	229	11901	39	16958	138	20944	271	25901	212	27916	45
01946	66	02868	249	04918	167	05973	130	11973	37	16984	138	20971	271	25902	212	27921	43
01947	67	02869	249	04920	168	05974	130	11974	39	16985	138	20973	271	25903	212	27922	43
01948	67	02870	249	04921	168	05976	170	12954	37	17905	41	20974	271	25905	212	27923	43
01949	66	02901	243	04922	168	05978	168	12955	39	17906	41	20992	268	25906	212	27924	43
01950	67	02902	243	04923	168	05979	168	12956	37	17909	35	21931	95	25907	212	27925	43
01958	66	02903	244	04924	168	05981	168	12957	39	17915	35	21945	273	25910	146	27926	43
01959	64	02904	244	04927	169	05982	168	13939	55	17921	35	21951	101	25912	153	28900	101
01960	70	02905	244	04928	169	05985	265	13940	55	17924	31	21955	94	25913	154	28906	87
01991	64	02911	242	04929	169	05988	163	13941	55	17951	31	21975	95	25915	146	28910	94
01992	64	02912	242	04962	162	05989	163	14943	59	17952	31	21995	272	25916	146	28912	90
01993	64	02923	245	04963	167	05990	163	14944	59	17953	31	21998	273	25917	147	28916	81
01996	68	02924	245	04964	162	05991	163	14945	59	17954	31	22900	269	25918	147	28917	93
02000	243	02926	245	04965	162	05992	163	14946	59	18819	94	22910	269	25934	154	28918	93
02001	243	02950	246	04970	167	05994	163	14947	59	18917	81	22912	270	25940	196	28931	101
02002	244	02951	246	04971	167	06827	249	14948	59	18919	100	22914	269	25942	196	30883	146
02030	242	02952	243	04972	167	06828	249	14975	53	18920	49	22916	269	25944	196	30900	151
02031	242	02953	243	04973	167	06829	249	14976	53	18921	49	22918	269	25949	272	30902	151
02036	244	02954	243	04974	167	06900	165	14977	53	18922	49	22922	269	25956	61	30904	147
02063	245	02972	243	04975	167	06915	165	14980	51	18923	49	22924	270	26570	189	30925	154
02123	246	02973	243	04976	167	06918	165	14981	51	18934	89	22928	268	26571	189	30926	154
02124	246	02974	243	04977	167	06919	165	14982	51	18935	91	22929	268	26572	189	30929	154
02125	246	03901	248	04992	162	06929	165	14985	53	18948	96	22932	269	26575	135	30930	154
02127	246	03918	277	05917	176	06971	165	14986	53	18972	49	22950	268	26576	135	30931	154
02130	246	03919	277	05918	176	06972	165	14987	53	18974	49	23999	77	26577	135	30945	154
02132	246	03929	249	05919	176	06973	165	14988	51	18975	49	24949	196	26578	135	30946	154
02135	246	03930	249	05920	176	06974	165	14989	51	18976	86	24958	196	26961	47	30949	154
02279	246	03931	249	05921	176	06975	165	14990	51	18978	96	24966	269	26962	47	30950	154
02396	246	03932	249	05922	176	06976	165	15901	57	18979	94	24967	269	26963	47	30955	154
02397	246	03952	248	05923	166	06977	165	15902	57	18980	70	24968	218	26970	193	30956	154
02839	249	03953	248	05924	166	06978	165	15904	57	18982	85	24969	218	26971	193	30958	154
02840	249	03954	248	05926	166	06979	165	15956	33	18983	88	24971	270	26972	193	30959	154
02841	249	03955	248	05927	166	06980	165	15957	33	18984	92	24973	270	26973	193	30960	154
02842	249	03956	248	05928	166	06981	249	15958	33	20900	271	24974	269	26974	193	30962	154
02846	249	03957	248	05929	166	06984	167	15959	33	20902	271	24976	129	26975	193	30963	154
02850	249	03958	248	05939	166	06985	167	16900	75	20905	268	24977	129	26980	191	30964	154
02851	249	03995	100	05961	168	06986	167	16901	137	20906	268	24979	129	26981	191	30972	148
02852	249	04904	169	05962	168	06987	167	16902	250	20907	265	24984	60	26992	47	30973	148
02853	249	04909	169	05963	168	10607	218	16903	195	20908	269	24985	60	26999	47	30974	146
02854	249	04910	163	05964	168	10913	97	16905	195	20914	270	24986	196	27900	45	30976	146
02855	249	04911	163	05965	168	10939	231	16906	195	20917	268	24988	269	27901	45	30986	147



# SYMBOLGY AND CERTIFICATIONS

In this catalogue to provide reader's with the maximum amount of information and to be as clearly as possible, we have used the following symbols:

	Prepare		Units per pallet		Segment Thickness		Cutting Length		Folding legs
	Cut & Drill		Units per box		Diamond band height		Cutting height		Mobile cart
	Set		Cutting length		Diamond band width		Separator power		Adjustable flow
	Grout		Diagonal cutting length		Maximum drill length		Fixed separator		Tip-up table for mitring
	Clean		Cutting height		Mixing capacity		Mobile separator		Zero Dust
	3+1 years warranty		Separator power		Max Height of the head		Repetitive cuts		Level
	3+2 years warranty		Net weight without packaging		Rod's head diametre		45° cuts		Laser
	3 year warranty		Gross weight		Wide notched trowel		Base accessory		C3 system
	Patented		With carrying case		Notched height trowel		Angular measuring		Wet cutting
	Patent Pending		Weight with carrying case		Notched Radius Trowel		Dual reinforced guide		Dry cutting
	Patent Pending		Power supply		Trowel length		PURE POWER		1 hour of continuous work maximum, recommended by TNO
	Secure Lock System		Revolutions per minute		Trowel width		MAGNET		3 hours of continuous work maximum, recommended by TNO
	European Regulatory Commission		Watts		Bags per box		Smart Power		
	Russian legislation EAC		Mitre cutting length		N° tile spacers per bag		One Hand Action		
	Normative UK		Mitre Thickness cut		Height of bucket		Back pack optional		
	TÜV safety rules		Maximum cutting thickness - 1 stroke or 2 strokes		Bottom diameter		Bearing system		
	TNO Innovation for life		Length Width Height		Top diameter		Easy fix		
	AD1		Wall chaser effect		Useable height		Ergonomic		
	Product Design Award		Cut length with saw effect		Sponge size		Soft		
	TUV mark		With blade		Absorption level (1-4)		INCH/MM. ruler		
			Outside diameter		Resistance to abrasion (1-4)		Power		
			Inside diameter				Foldable head		
			Disc segment high				Plunge Effect		



Rubi Group comply with the Directive 2002/96/EC on waste electrical and/or electronic and Directive 2002/95/EC on the restriction of certain substances in their manufacture, applying the law of each member state according to EEC your specific criteria. [WEEE, WEEE, ECDRAEE, etc...] [RoHS].

Images are for illustration purposes and may change without notice.

\*The gross weight of some electrical machines may vary depending on the type of pallet and carton type used in packaging.

\*\*Any manipulation or modification of machine voids the warranty. Our warranty covers defects in manufacturing or assembly in accordance with the applicable law.

Note: Any reproduction of all or part of this catalogue without prior approval of Germans Boada, SA is forbidden



# RUBICLUB

## JOIN THE COMMUNITY OF 70.000+ EXPERTS IN THE ART OF TILING

1. SIGN UP IN LESS THAN 1 MINUTE
2. EXTEND THE WARRANTY OF YOUR PURCHASES EASILY
3. GAIN ACCESS TO EXCLUSIVE BENEFITS AND GIFTS

SCAN THE QR CODE OR  
ENTER [WWW.RUBI.COM](http://WWW.RUBI.COM)



After Sales Service  
[aftersales@rubi.com](mailto:aftersales@rubi.com)



## RUBI GROUP

**SP** **GERMANS BOADA, S.A.**  
**BARCELONA (OFICINAS CENTRALES)**  
Pol. Can Rosés,  
Avda. Olimpiades 89-91, P.O.BOX 14  
08191 RUBI (Barcelona) SPAIN  
T. 34 936 80 65 00  
[info@rubi.com](mailto:info@rubi.com)

**MADRID**  
Marie Curie,7  
Edif. B, bajos 7  
28521 Rivas Vaciamadrid SPAIN  
T. 34 914 99 48 63  
[rubiMadrid@rubi.com](mailto:rubiMadrid@rubi.com)

**PT** **RUBI PORTUGAL**  
Rua da Ribeira de Eiras, S/N, Armazém B  
Ponte de Eiras  
3020-324 Coimbra - PORTUGAL  
T. 351 239 492 430  
F. 351 239 492 431  
[rubiportugal@rubi.com](mailto:rubiportugal@rubi.com)

**FR** **RUBI FRANCE S.A.R.L.**  
15 Avenue du Hoggar  
Bâtiment le Vancouver  
91940 LES ULIS - FRANCE  
T. 33 1 69 18 17 85  
T. 33 1 69 18 17 89  
[rubiFrance@rubi.com](mailto:rubiFrance@rubi.com)

**US** **RUBI TOOLS USA Inc.**  
10702 NW 147th Street, Suite 100  
Hialeah Gardens, FLORIDA 33018 USA  
P. 1 305 715 9892  
F. 1 305 715 9898  
[rubitools.usa@rubi.com](mailto:rubitools.usa@rubi.com)

**UK** **RUBI UK LTD.**  
Units 16 & 17, Easter Park,  
Ferry Lane  
Rainham, Essex  
RM13 9BP - UNITED KINGDOM  
P. 44 (0) 1708559609  
F. 44 (0) 1708553813  
[rubiuk@rubi.com](mailto:rubiuk@rubi.com)

**PL** **RUBI POLSKA Sp. z o.o.**  
ul. Dawidowska 10, Zamienie  
05-500 Piaseczno  
POLSKA  
T. +48 (0) 226 44 51 61  
F. +48 (0) 226 44 58 45  
[rubipolska@rubi.com](mailto:rubipolska@rubi.com)

**NL** **RUBI BENELUX BV**  
Weidehek, 70  
4824 AS BREDA  
NEDERLAND  
**LU**  
**BE**  
T. 31 (0) 76 57 29 200  
F. 31 (0) 76 57 20 190  
[rubiBenelux@rubi.com](mailto:rubiBenelux@rubi.com)

**DE** **RUBI DEUTSCHLAND GmbH**  
Krahnendonk 89  
41066 Mönchengladbach  
DEUTSCHLAND  
**AT**  
T. 49 (0) 2161 990 60 90  
F. 49 (0) 2161 478 12 69  
[rubideutschland@rubi.com](mailto:rubideutschland@rubi.com)

**CA** **RUBI CANADA**  
9209 Boul Langellier  
St-Léonard, Qc CA H1P-3K9  
P. 1866 898 7924  
[rubicanada@rubi.com](mailto:rubicanada@rubi.com)

**IT** **ITALIA**  
T. 800 788278  
F. 800 788279  
[commerciale@rubi.com](mailto:commerciale@rubi.com)

**CN** **Suzhou Rubi Technologies Co., Ltd.**  
Block 2, No.86, Tinghe Road, SIP, Suzhou City,  
Jiangsu, Province, China  
Zip Code: 215121  
中国江苏省苏州工业园区亭和路86号2号厂房  
苏州瑞比机电科技有限公司  
邮政编码: 215121  
Tel: 86 512 66626100

**IN** **RUBI INDIA**  
Andheri Kurla Road, Andheri (East)  
Mumbai-400059, India  
T.+91 22 67587457 60  
[rubiwestindia@rubi.com](mailto:rubiwestindia@rubi.com)

**MX** **GERMANS BOADA MEXICO**  
Av. Industria Moderna #2001 Bodega 82,  
El Cerrito, CP 76240  
El marqués, QRO  
T. +52 55 5592 4907  
T. +52 55 5592 5386  
[mexico@rubi.com](mailto:mexico@rubi.com)

**CO** **RUBI COLOMBIA**  
Cra. 11a #94-56, Oficina 501  
Bogotá D.C. COLOMBIA  
T. (+571) 441 45 46

**CL** **RUBI CHILE**  
GERMANS BOADA S.A.  
Los Militares # 5620, Oficina 1503  
Los Condes (Santiago de Chile) CHILE  
T. (+562) 3339 9193  
T. (+569) 9799 9574  
[rubiChile@rubi.com](mailto:rubiChile@rubi.com)

**AE** **RUBI MIDDLE EAST**  
P.O. Box 507070, Unit 08A, Level 7,  
Al Fattan Currency House-Tower 1,  
Dubai IFC, Dubai, United Arab Emirates  
[nkhan@rubi.com](mailto:nkhan@rubi.com)  
T. +971 52 969 7852

**TR** **RUBI TURQUIA**  
TAMER OZALLI Hird. Hizm.  
Fulya Mah: Mehmetcik cad Kozacik sok  
Birlik ap D.3 Şişli / İstanbul  
T. +90 50 7624 0167  
[tozalli@rubi.com](mailto:tozalli@rubi.com)

