

DEHUMIDIFIER

DH 44

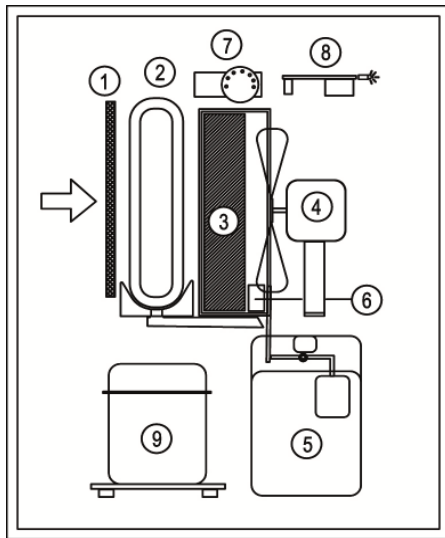

FUNCTIONING DIAGRAM



1	:	Filter
2	:	Evaporator
3	:	Condenser
4	:	Fan
5	:	Tank
6	:	Switch
7	:	Moisture gauge
8	:	Electronic board
9	:	Compressor

TECHINICAL DATA

Functioning Relative Humidity Range	%	35-99
Functioning Temperature Range	°C	3 - 35
Air Flow	m ³ /h	480
Rated Condensation Capacity (30°C UR 80%)	l/24h	40
Type of Refrigerant Gas		R410A
Quantity of Refrigerant Gas	g	640
Voltage Power Supply	V	220-240
Frequency Power Supply	Hz	50
Power Consumption (35°C UR 99%)	W	780
Absorbed Current (35°C UR 99%)	A	3,9
Sound Pressure Level (at 3 mts)	dBa	53
Capacity of Condensed Water Tank	l/24h	11
Weight	Kg	43

PACKING

Dimensions packing	mm	555 x 715 x 925
Dimensions utilization	mm	600 x 580 x 850
Pieces for Europallet	n°	1
Pieces full truck	n°	231

PERFORMANCE

